

LNC-M520i

Operator's Manual

2008/1 Ver: V04.00.001(4408210025)

Leading Numerical Controller



LNC Technology Co., Ltd.

Table of Content

1	GENERAL	1
1.1	HARDWARE SPECIFICATION	2
1.2	SOFTWARE SPECIFICATION	3
1.3	SYSTEM SETTING UNIT	4
1.4	G CODE TABLE	5
2	CNC OPERATION	8
2.1	OPERATION DEVICES TYPE	8
2.2	OPERATION DEVICES INTRODUCE	9
2.3	SCREEN AND FUNCTION DESCRIPTION	14
2.3.1	Display Screen Layout	14
2.3.2	Function Group Figure	15
2.4	POS FUNCTION	26
2.4.1	ABSOLUTE COORDINATE	27
2.4.2	RELATIVE COORDINATE	28
2.4.3	MACHINERY COORDINATE	29
2.4.4	MEA (Measure)	30
2.4.5	EXIT	32
2.5	PROG	33
2.5.1	FGPROG	34
2.5.2	BGPROG (Background Program)	41
2.5.3	DIRMNG (File Management)	42
2.5.4	PROCHK (Program Checking).....	48
2.5.5	MDI	49
2.5.6	COMM (Communication of Files (RS232)).....	50
2.5.7	DNC Function	55
2.6	OFFSET	56
2.6.1	TOOL OFFSET	56
2.6.2	MACRO.....	57
2.6.3	WORK.....	58
2.7	MILLING EASY-CAM.....	60

2.7.1	Preface.....	60
2.7.2	Function Specification	60
2.7.3	CUT PAR (Cutting Parameter)	61
2.7.4	Screen Operation Description	63
2.8	MILLING FIGURE CONVERSATION	68
2.8.1	PREFACE	68
2.8.2	Function Specification	68
2.8.3	Work Production Selection.....	68
2.8.4	Common Parameters Setting.....	73
2.8.5	Cutting Parameter Setting.....	73
2.8.6	Operation Screen Description	74
2.9	GRAPH.....	79
2.9.1	Function Introduction.....	79
2.9.2	GRAPH	79
2.9.3	SET	80
2.10	DGNOS	82
2.10.1	ALARM.....	82
2.10.2	IOCSA.....	85
2.10.3	MLC2	86
2.10.4	SYSTEM	87
2.10.5	Working Parameter Page.....	90
2.10.6	SYSUPD	91
2.10.7	CIRCUL.....	98
2.11	SOFTPL.....	100
2.12	PARAM	103
2.12.1	NC. SYS.....	103
2.12.2	USROPT (Users Parameter).....	107
2.12.3	LNCS	108
2.13	RESET.....	112
3	OP PANEL OPERATION.....	113
3.1	OPERATION AREA.....	113
3.2	POWER SWITCH (ON/OFF)	114
3.3	EMG-STOP KEY.....	114

3.4	CYCLE START	115
3.5	FEED HOLD	116
3.6	LED SIGNAL.....	117
3.7	MODE SELECT	118
3.8	AXIS SELECTION	120
3.9	SPINDLE ROTATION.....	121
3.10	OT RELEASE	122
3.11	COOLANT SUPPLY.....	123
3.12	TOOL MAGAZINE.....	124
3.13	SINGLE BLOCK STOP	124
3.14	ADDITIONAL FUNCTION SELECTION	125

1 General

LNC-M520i is a PC-based controller for CNC milling machines. It is a high-tech product that is developed by the POU YUEN TECHNOLOGY Ltd. through years of dedicated research and development, involving massive manpower and resources. LNC-520i serial controller features in high-speed, high-precision, high-efficiency. In the following chapters, we will introduce you how to operate LNC-M520i controller.

1.1 Hardware Specification

LNC-520i	Specification
Monitor	8.4" TFT LCD
SDRAM	32M or above
Dual CF Card	32M or above
Floppy; Power supply	FDD ; 5V/12V
CPU BOARD	IPC
Spindle System	Pulse control / DA output
Remote I/O	128 Input/128 Output
USER I/O	20 Input/16 Output
Servo System	position loop / speed loop control
DNC	RS232 19200 Baud Rate
OP Panel	Standard Milling Panel
MPG Interface	3-in-1 MPG
Max Control Axes	4 axes Pulse
Spindle	1
Input	(1 st input) 12V(2A) 、 5V(6A)
<<MUST use dual power supply>>	(2 nd input) 24V(4A)

1.2 Software Specification

LNC-M520i	Specification
File Types	DOS FAT
Program Specifications	Normal G, M Code Program
	Background Editing Function
	MACRO Program Function
Modes	EDIT Mode
	MEM Mode
	MDI Mode
	JOG Mode
	MPG Mode
	RAPID Mode
	HOME Mode
Group Functions	POS Function
	PROG Function
	OFFSET Function
	CAM Function
	GRAPH Function
	DGNOS Function
	SOFTPL Function
	PARAM Function
MLC (Machine Logic Controller)	I/O/C/S/A BIT
	Timer/Counter/Register
	Immediately Ladder Program Display
Language	Simplify/Traditional Chinese and English

1.3 System Setting Unit

Smallest Input Unit	Smallest Commanding Value	Maximum Travel Setting
0.001 mm	0.001 mm	99999.999 mm
0.0001 inch	0.0001 inch	9999.9999 inch
0.001 deg	0.001 deg	99999.999 deg

1.4 G Code Table

G Code	G Code Function	Group
G00	Positioning(Rapid Traverse)	01
G01	Linear Interpolation(Cutting Feed)	01
G02 , G03	Circular Interpolation(CW/CCW)	01
G04	Dwell	00
G09	Exact Stop	00
G10	Programmable Data Input	00
G15	Polar Coordinate Command Cancel	17
G16	Polar Coordinate Command	17
G17	XY Plane Selection	02
G18	ZX Plane Selection	02
G19	YZ Plane Selection	02
G20	Input in Inch	06
G21	Input in mm	06
G22	Stored Stroke Check Function ON	00
G23	Stored Stroke Check Function OFF	00
G27	Return to Reference Position	00
G28	1 st Reference Position	00
G29	1 st Reference Position Return	00
G30	2 nd /3 rd /4 th Reference Position Return	00
G31	Skip Signal Block Finish	00
G40	Tool Nose Compensation Cancel	07
G41	Tool Nose Compensation Left	07
G42	Tool Nose Compensation Right	07
G43	Tool Length Compensation in + Direction	08
G44	Tool Length Compensation in - Direction	08
G49	Tool Length Compensation Cancel	08
G50	Scaling Cancel	11

G Code	G Code Function	Group
G51	Scaling	11
G52	Local Coordinate Setting	00
G53	Machine Coordinate Selection	00
G54 ~ G59	Working Coordinate System Selection	14
G61	Exact Stop Mode	15
G64	Normal Cutting Mode	15
G65	MACRO Calling	12
G66	MACRO Modal Calling	12
G67	MACRO Modal Calling Cancel	12
G68	Coordinate Rotation Command	16
G69	Coordinate Rotation Command Cancel	16
G73	High-Speed Peck-Drilling Cycle	09
G74	Left Thread Tapping Cycle	09
G76	Fine-Grooving Cycle	09
G80	Cancel Constant Canned Cycle Cutting	09
G81	Drilling Cycle	09
G82	Drilling Cycle	09
G83	Peck-Drilling Cycle	09
G84	Right Thread Tapping Cycle	09
G85	Scissor Cycle	09
G86	Grooving Cycle	09
G87	Back Groove-Cutting	09
G88	Grooving Cycle	09
G89	Scissor Cycle	09
G90	Absolute Programming	03
G91	Incremental Programming	03
G92	Coordinate System Setting or Spindle Speed Setting	00

G Code	G Code Function	Group
G94	Per Minute Feed(mm/min.)	05
G95	Per Rotation Feed(mm/rev.)	05
G98	Return to Initial Level	10
G99	Return to R Point Level	10
G100	Common Parameters Setting	Macro
G101	Linear Module Positioning	Macro
G102	Circle Module Positioning	Macro
G103	Arc Module Positioning	Macro
G104	Grid Module Positioning	Macro
G105	Random Module Positioning	Macro
G111	X Axis Two-Way Facing	Macro
G112	Y Axis Two-Way Facing	Macro
G113	X Axis One-Way Facing	Macro
G114	Y Axis One-Way Facing	Macro
G121	Circular Side Cutting	Macro
G122	Rectangular Side Cutting	Macro
G123	Track Side Cutting	Macro
G131	Circular Pocketing	Macro
G132	Rectangular Corner Pocketing	Macro
G133	Rectangular Chamfer Pocketing	Macro

2 CNC Operation

2.1 Operation Devices Type

The control panels can be divided into two areas: **MDI** and **OP**. The MDI area is used to edit part programs as well as to enter relevant working data. The OP area, on the other hand, is used to manipulate operational conditions. There are multiple function keys, keys and pulse generator (hand wheel) and etc.

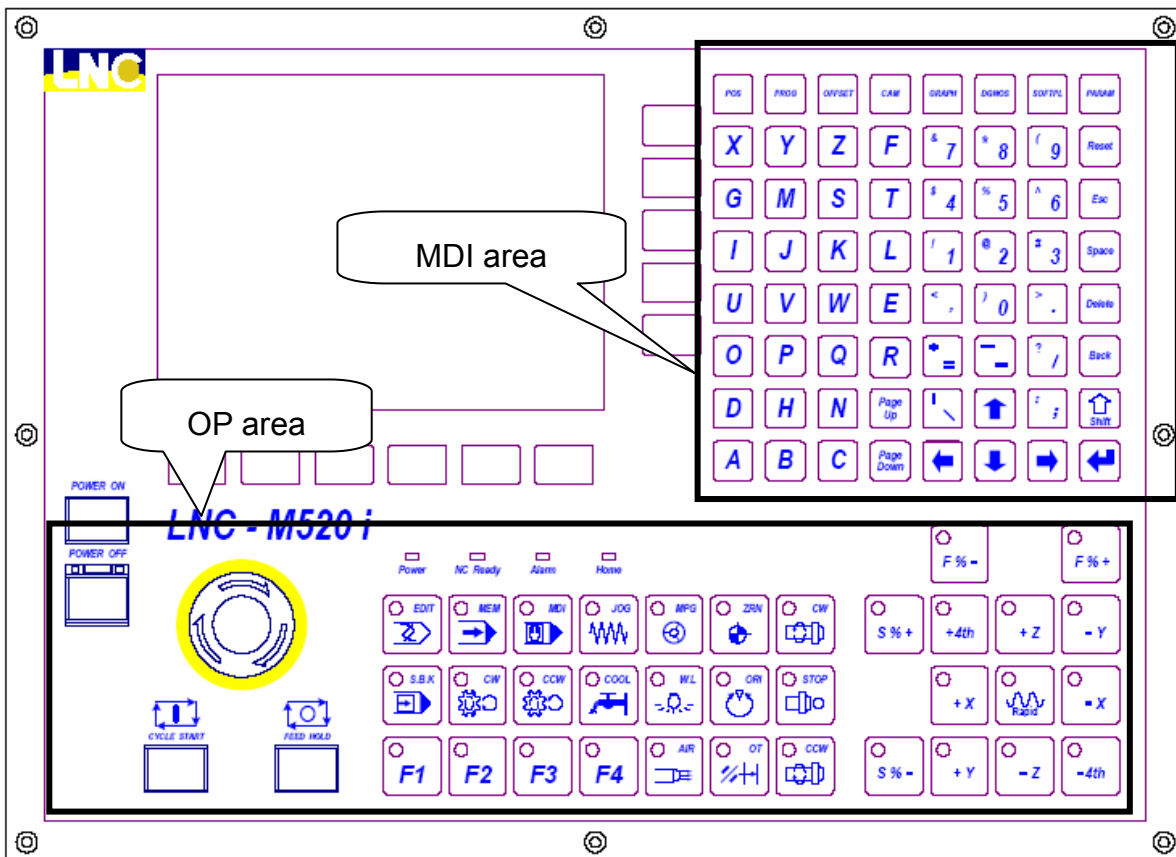

2.2 Operation Devices Introduce

The following will introduce 4 types of function keys, based on their function.

(1) Main Function Keys :

There are 6 horizontal function buttons at bottom of LCD screen. Users can choose the desired function button corresponding to those function selections at bottom of the display screen by press them.

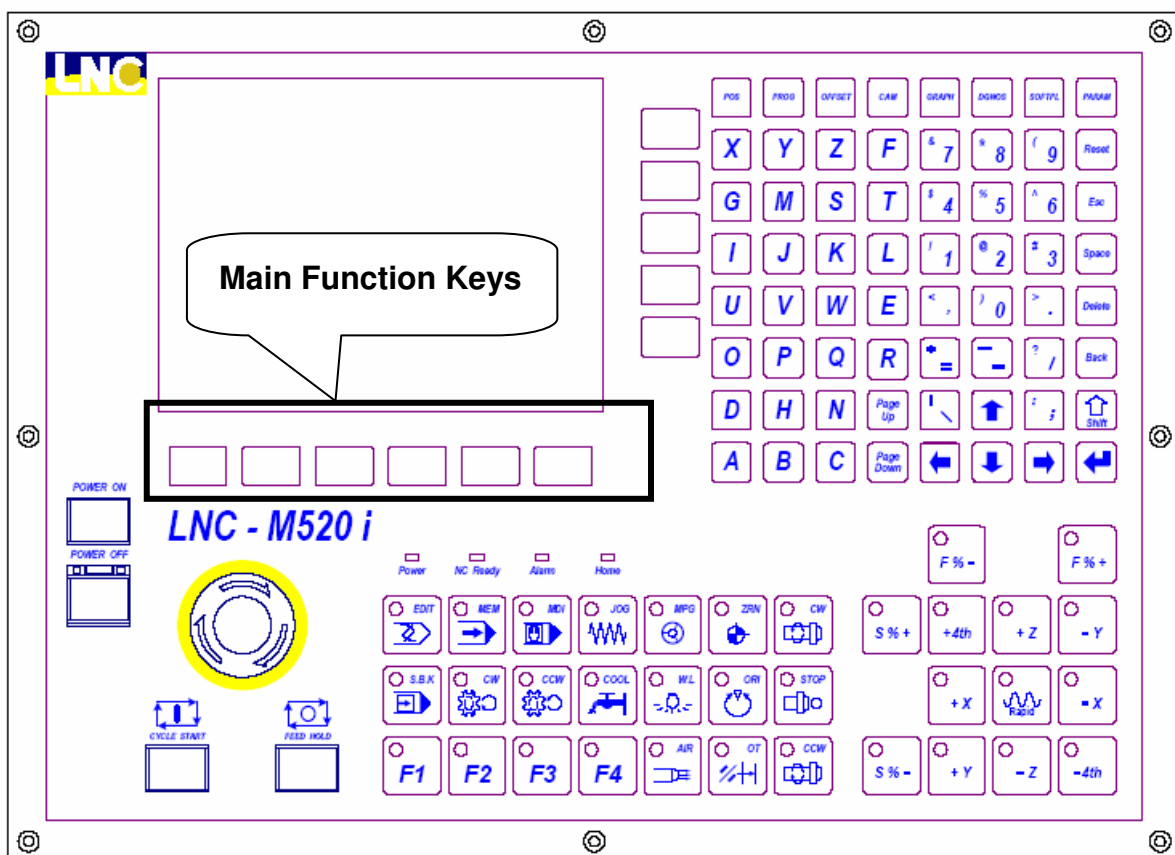

(2) **Sub-Function Keys :**

After choosing the main function button, the content of sub-function will occur at right side of the screen. Pressing the corresponding function button to select the wanted function. Left diagram shows the sub-function content of the corresponding coordinate (main function buttons). Selecting any one function, the screen will display the last chosen screen.

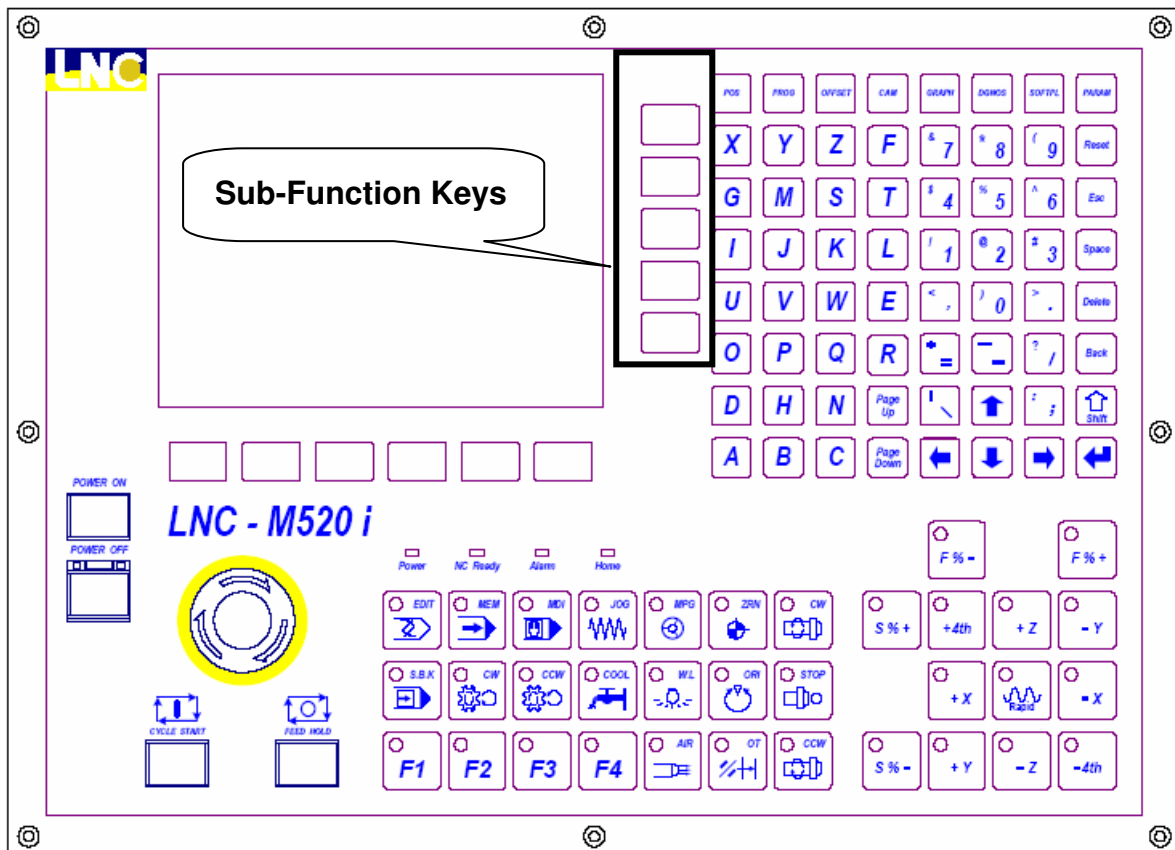

(3) **Function Group Selection Keys :**

To select 8 functions such are **POS, PROG, OFFSET, CAM, GRAPH, DGNOS, SOFTPL** and **PARAM**.

1. <POS> : to display positions
2. <PROG> : to edit and to display program
3. <OFFSET> : to set and to display tool offset
4. <CAM> : to edit working program by Figure method
5. <GRAPH> : to draw tool path
6. <DGNOS> : to display instance message at DGNOS page
7. <SOFTPL> : to select software panel switches
8. <PARAM> : to display parameter screen

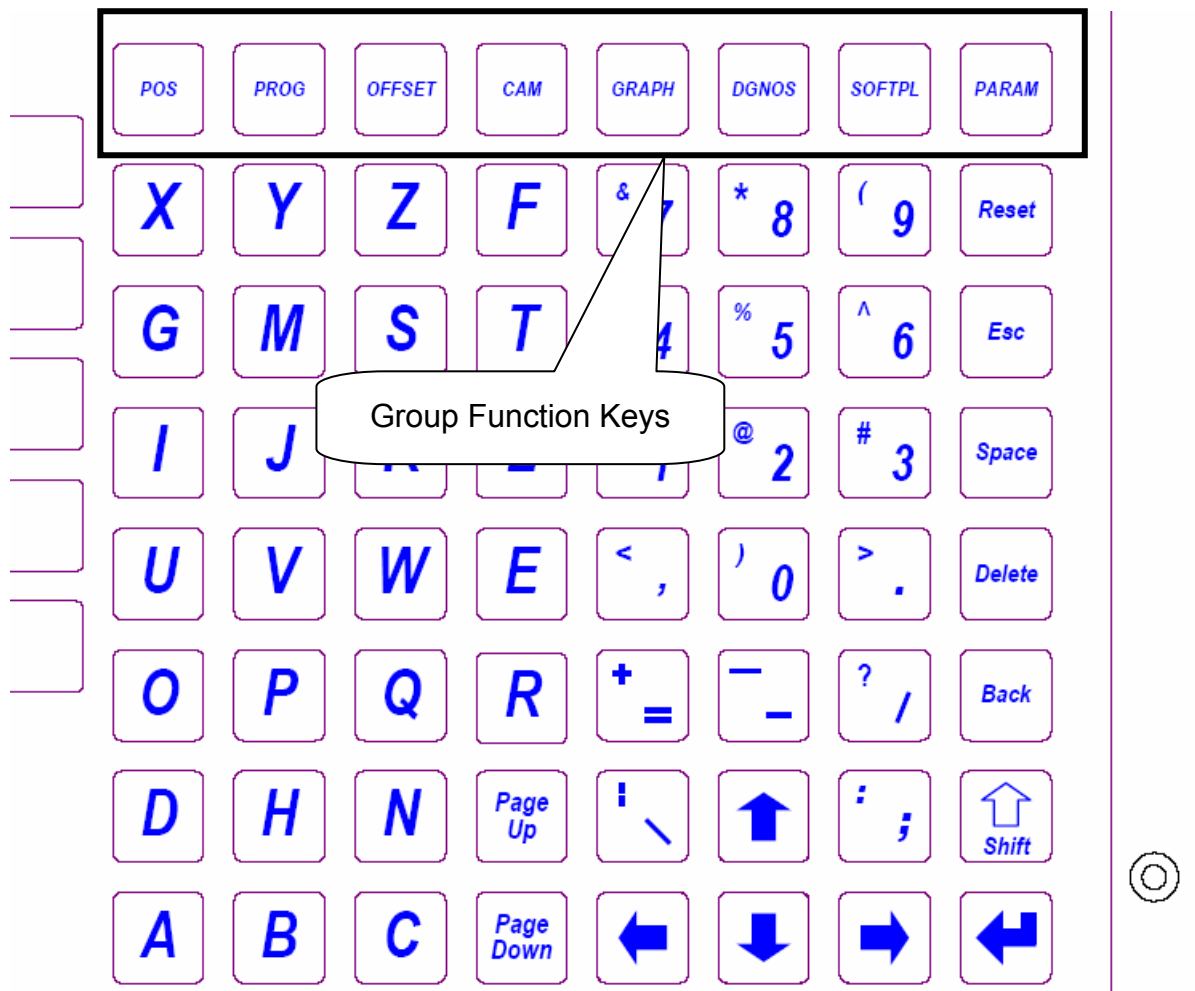

(4) Character & Symbol Keys & Editing Keys:

These characters, symbols and numbers are used for program editing and data key-in. There are some symbols that are diminished down at right-bottom of these keys. If want to use these symbols, please press SHIFT and the symbol key at the same time.

1. <Reset> : To reset system.
2. <Esc> : To cancel the dialog box
3. <Space> : To key-in into empty space.
4. <Delete> : To delete.
5. <Back> : To cancel the previous character.
6. <Shift> : To key-in special symbols with use of symbol number keys.
7. <INPUT> : To confirm entered data.
8. <Page Up> : To turn to the previous page.
9. <Page Down> : To turn to the next page.
10. <↔> : To move cursor right.
11. <←> : To move cursor left.
12. <↑> : To move cursor up.
13. <↓> : To move cursor down.

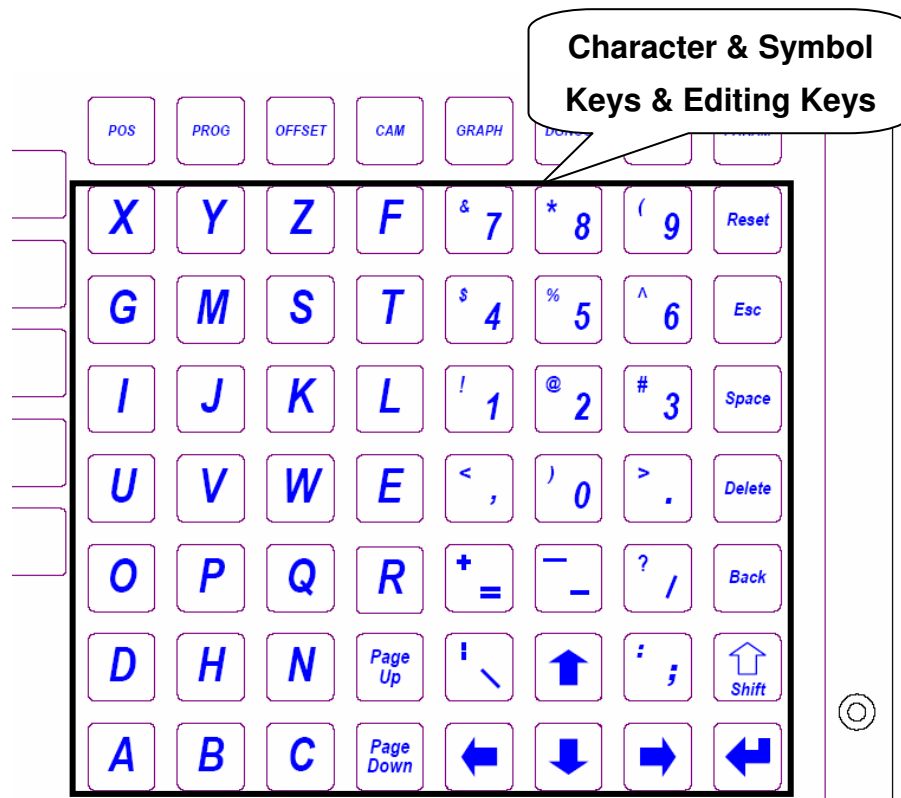

2.3 Screen and Function Description

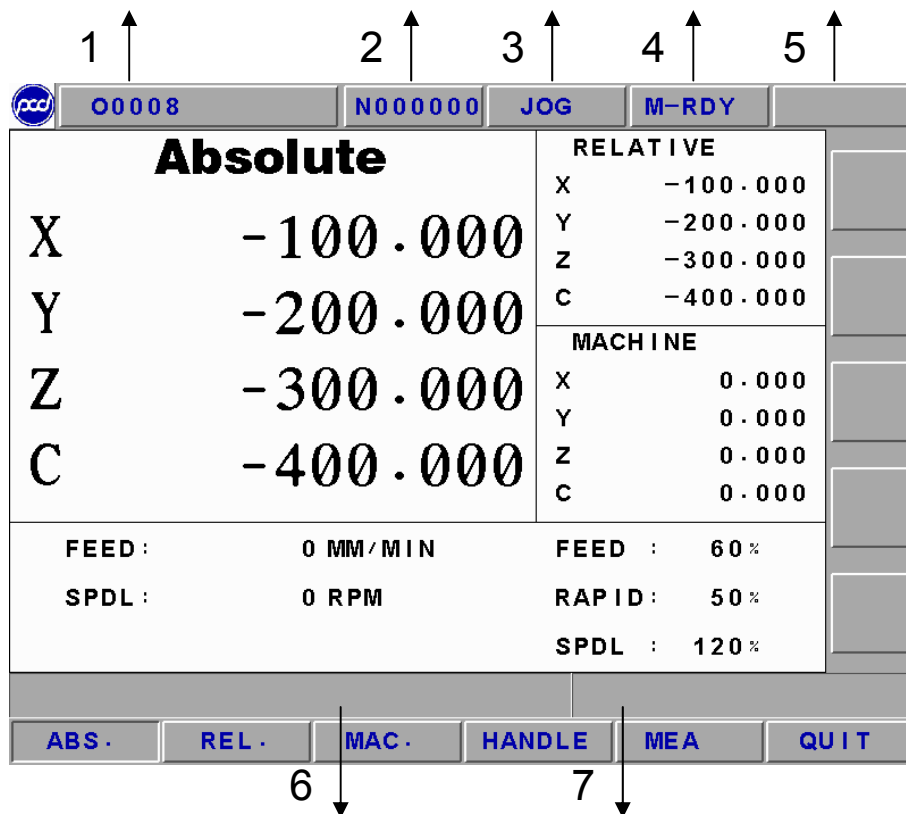

8 function groups in this controller: **POS**, **PROG**, **OFFSET**, **CAM**, **GRAPH**, **DGNOS**, **SOFTPL** and **PARAM**. Using **【...】** to indicate function keys at bottom and at right of the screen and using **<...>** to indicate keys on MDI panel.

2.3.1 Display Screen Layout

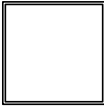
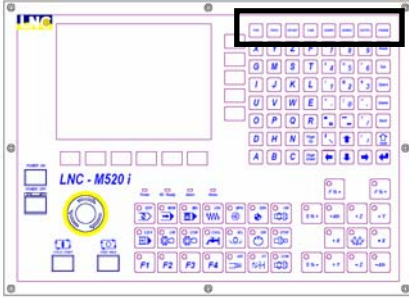

- 1 : present designate file name
- 2 : present single block that is executed by controller
- 3 : CNC mode signal
- 4 : machine condition signal
- 5 : wrong alarm/warning message
- 6 : simply message hint area
- 7 : entry area

2.3.2 Function Group Figure

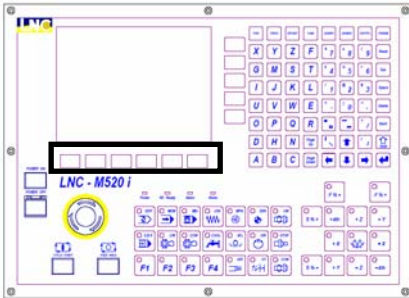
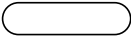
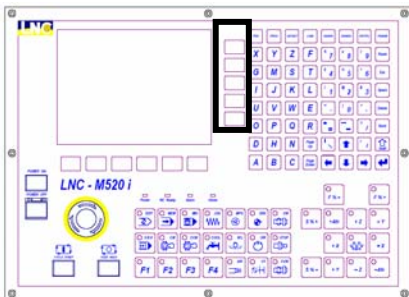
Figure Example	Real Example	Indication
		<p>Function group keys on MDI Panel.</p>
		<p>Main function keys at button of LCD.</p>
		<p>Sub function keys at right of LCD.</p>

● POS Function Key Tree Figure

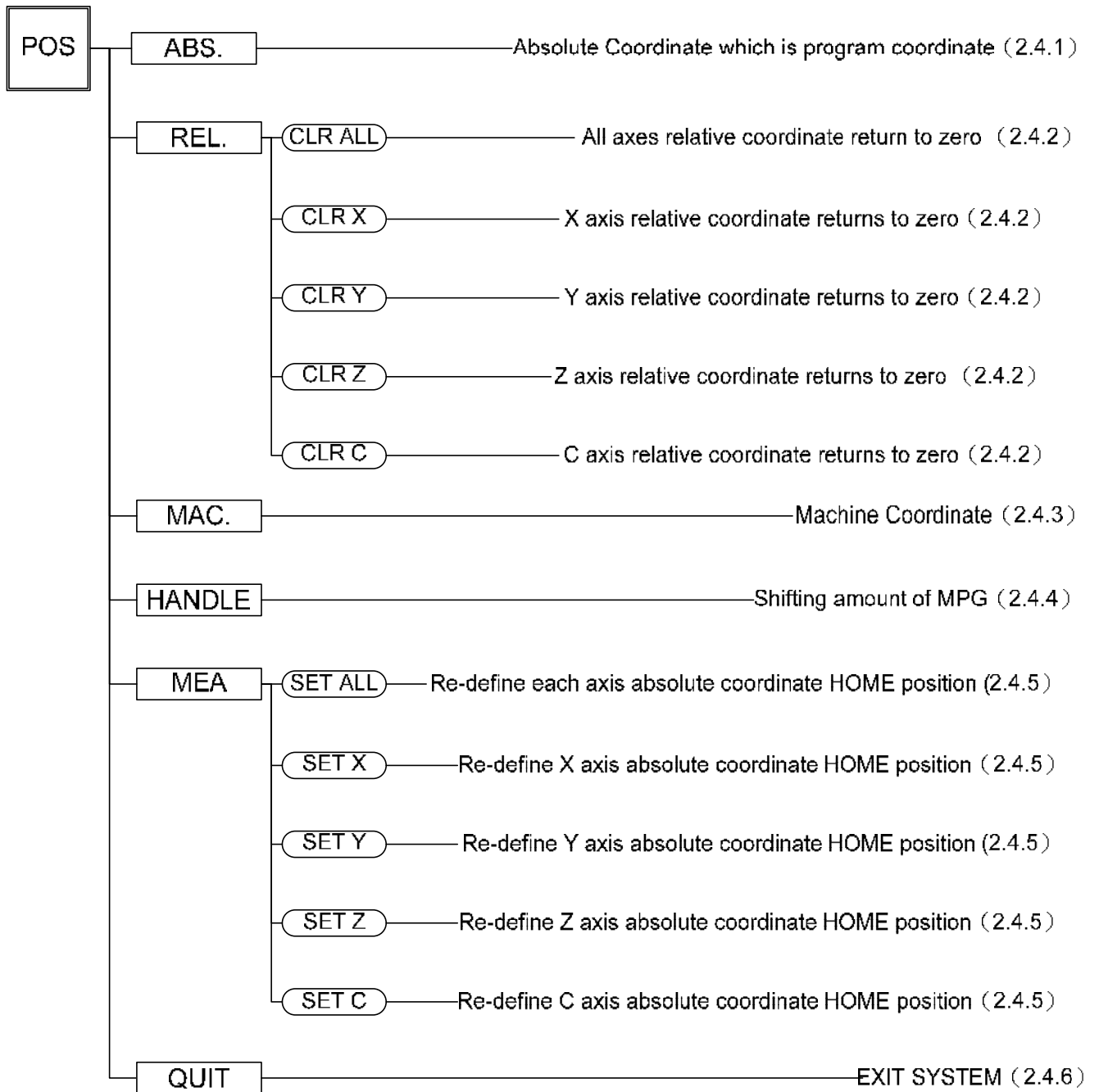

● **PROG Function Key Tree Figure**

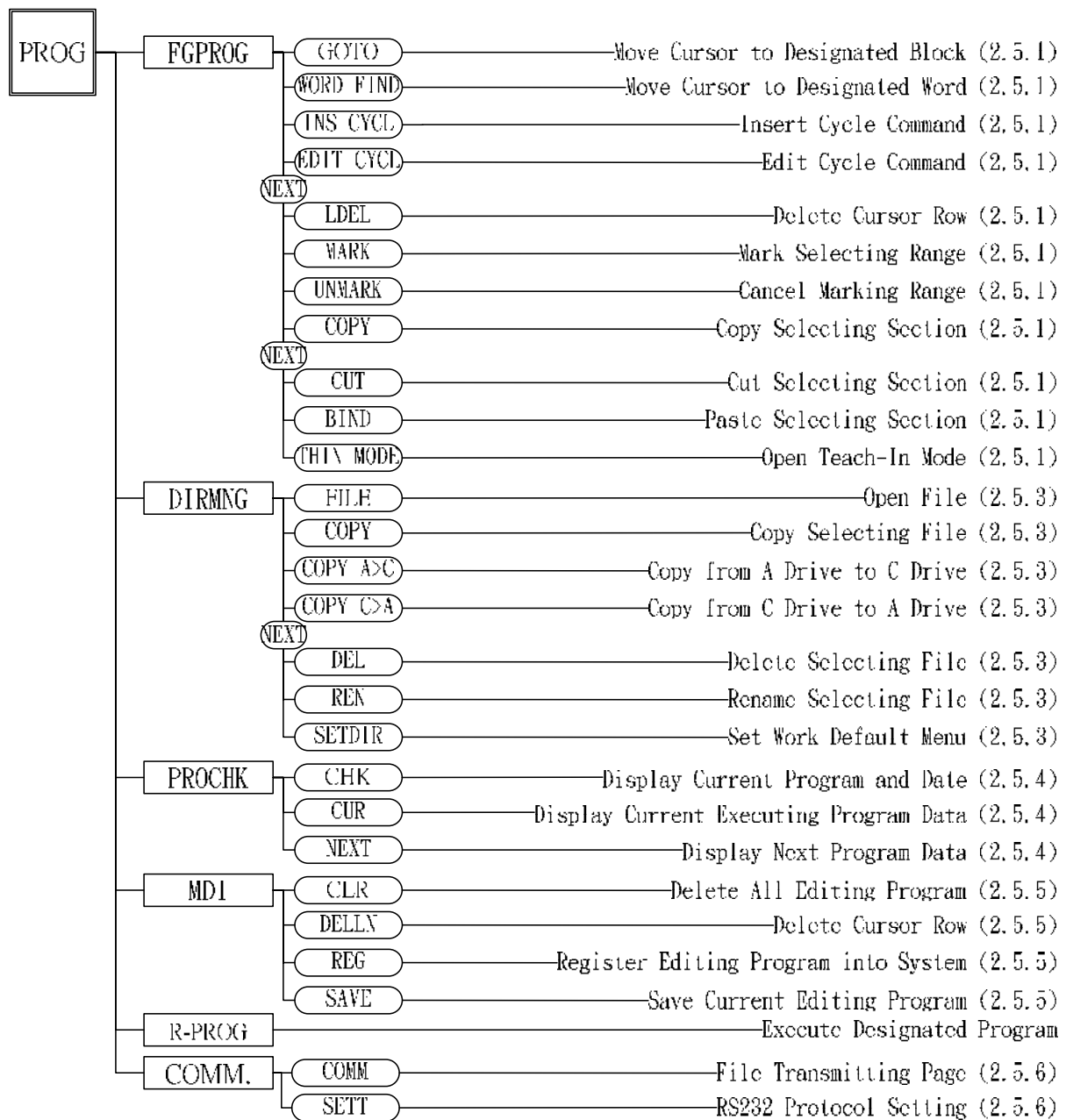

● **OFFSET Function Key Tree Figure**

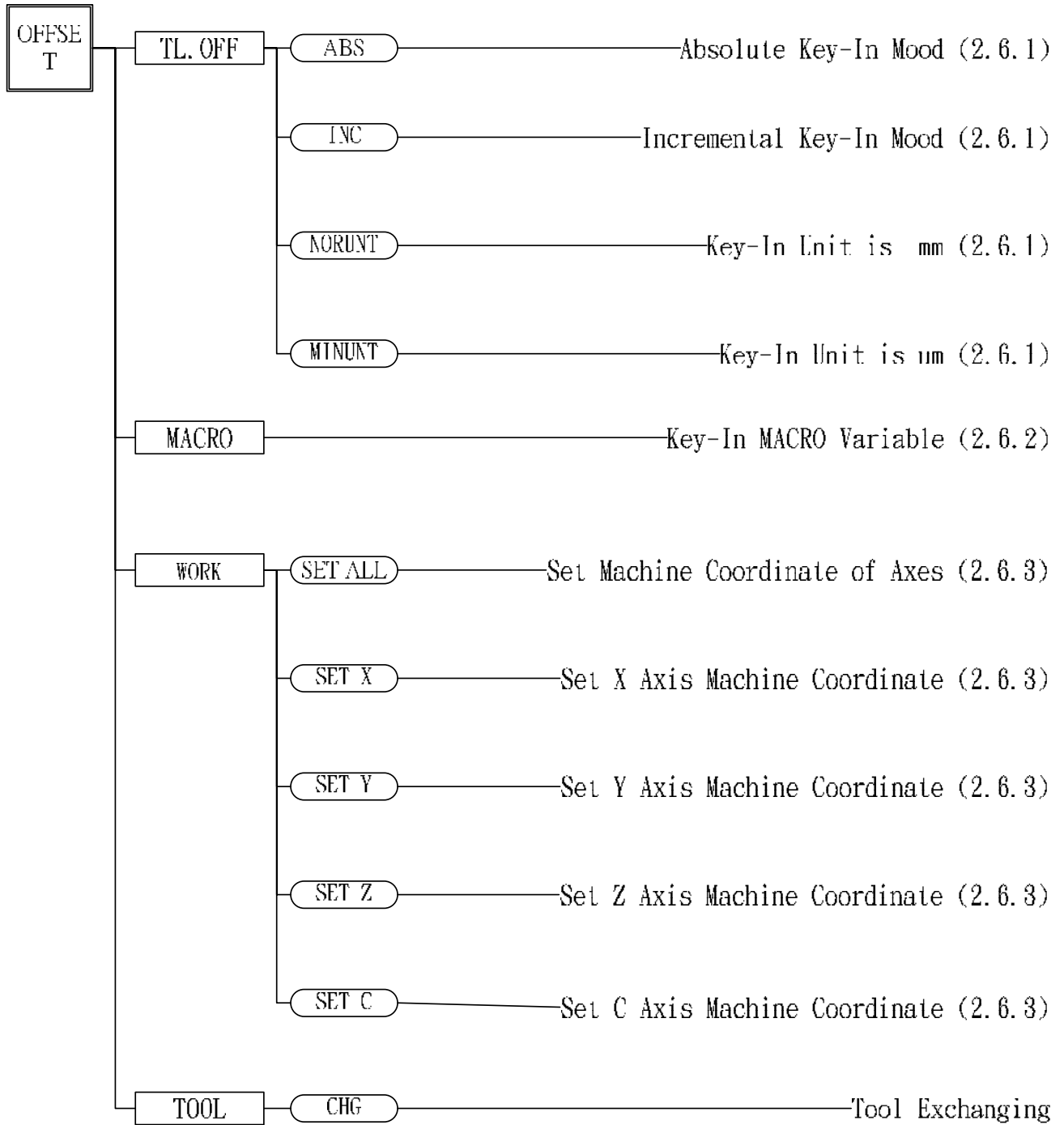

● CAM Function Key Tree Figure

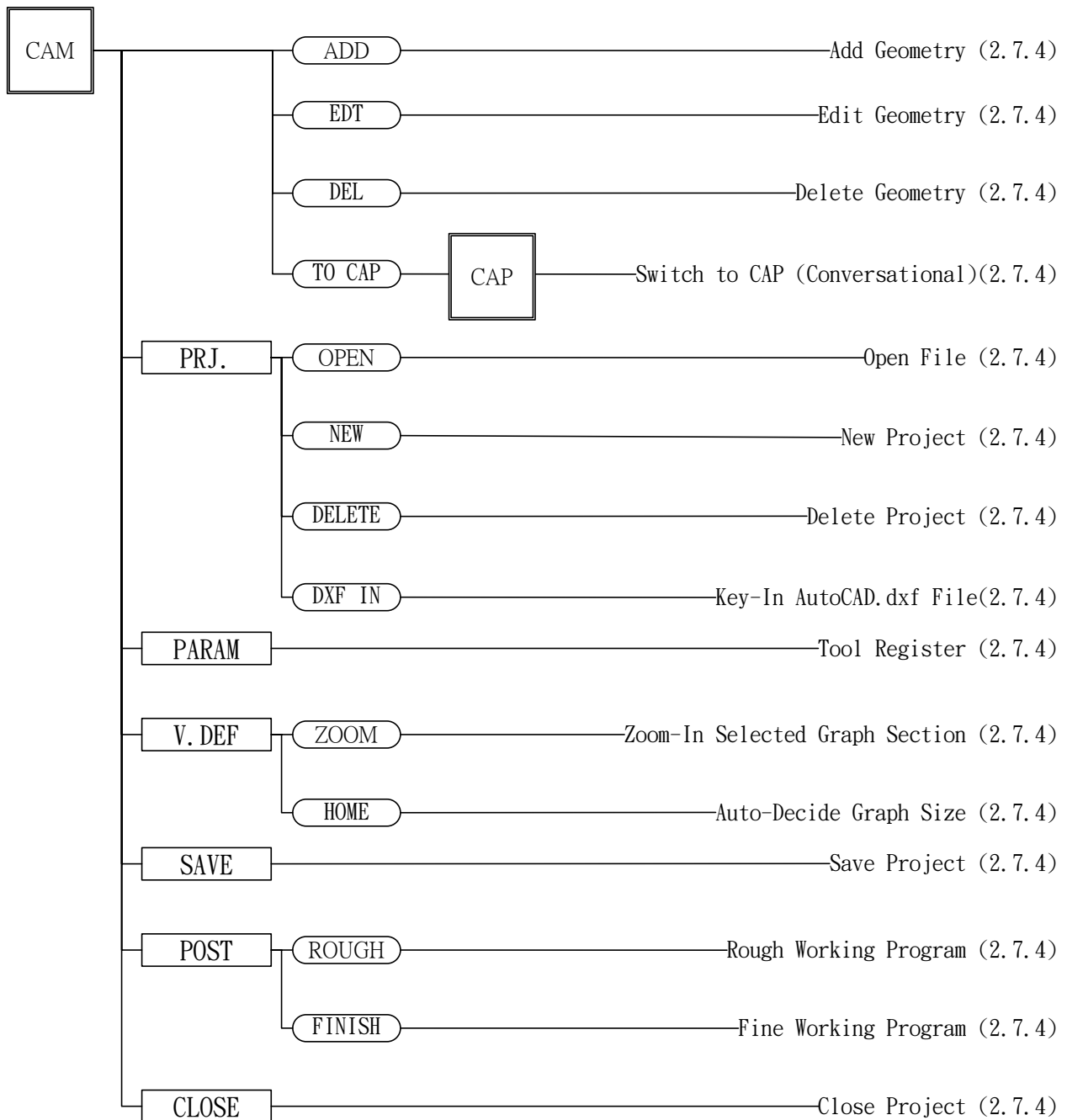

Note: There is no actual CAP key on MDI. Here just indicate easy use.

● **CAP Function Key Tree Figure**

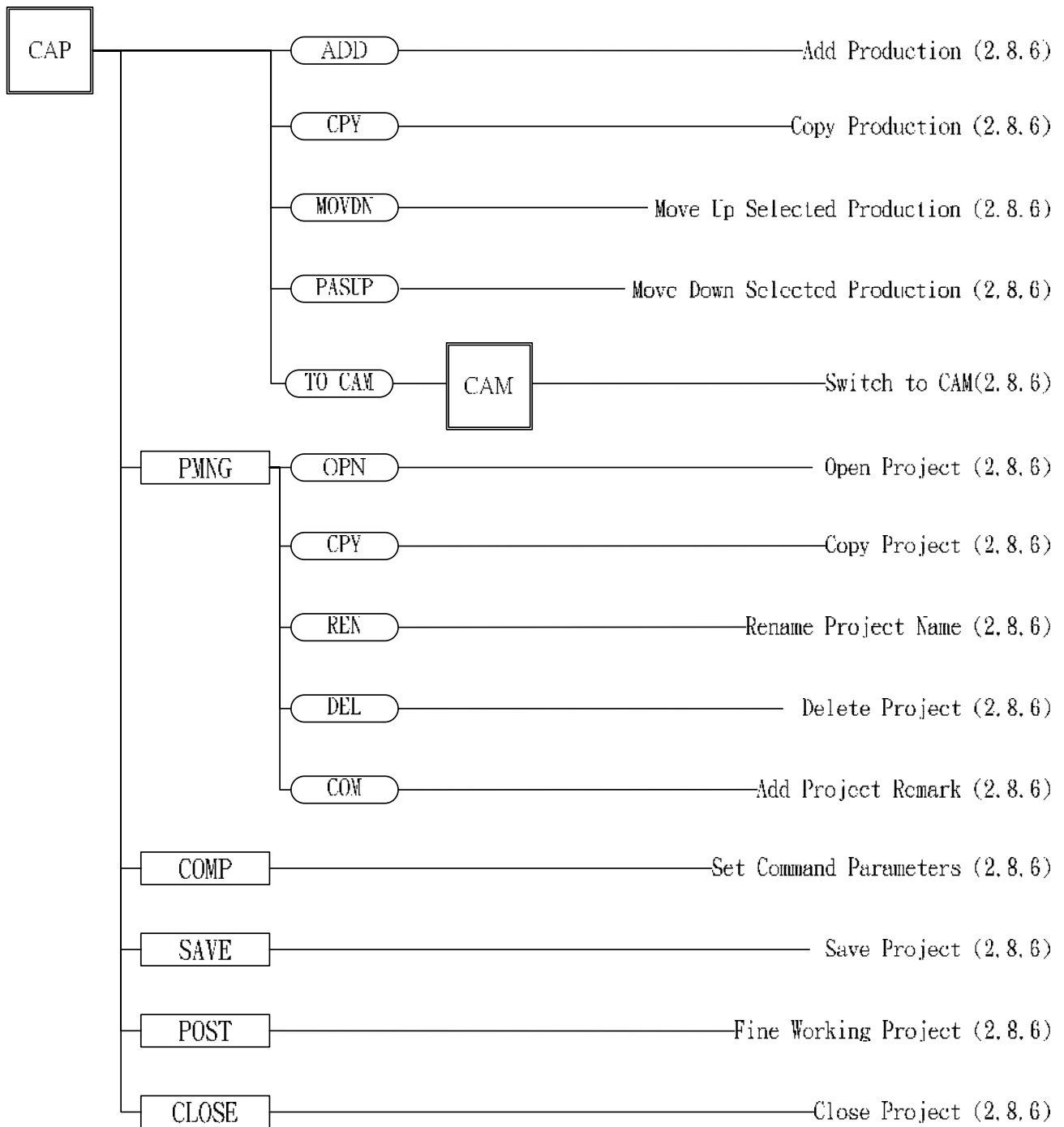

Note: There is no actual CAP key on MDI. Here just indicate easy use.

● GRAPH Function Key Tree Figure

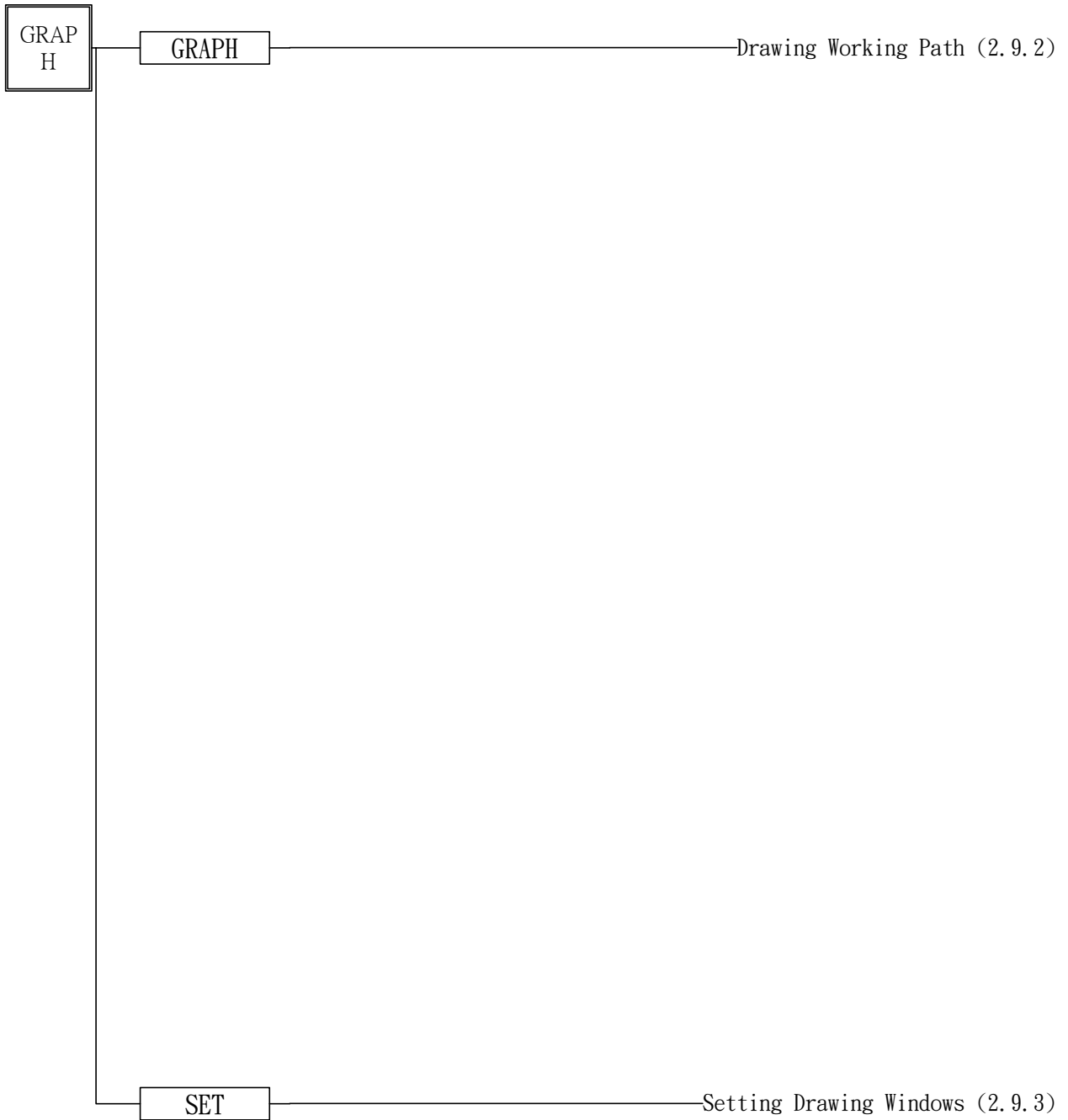

● **DGNOS Function Key Tree Figure**

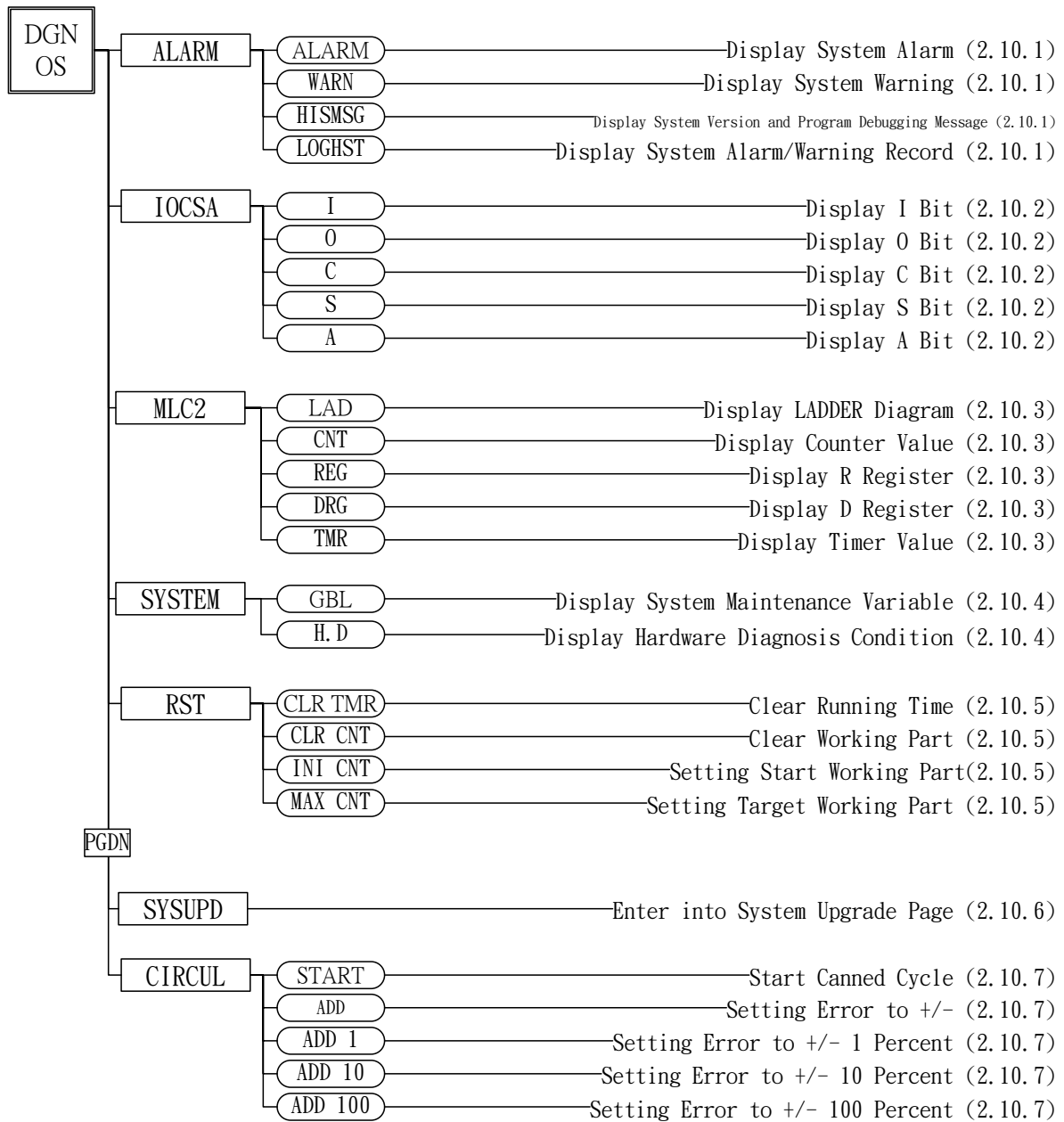

● **SOFTPL Function Key Tree Figure**

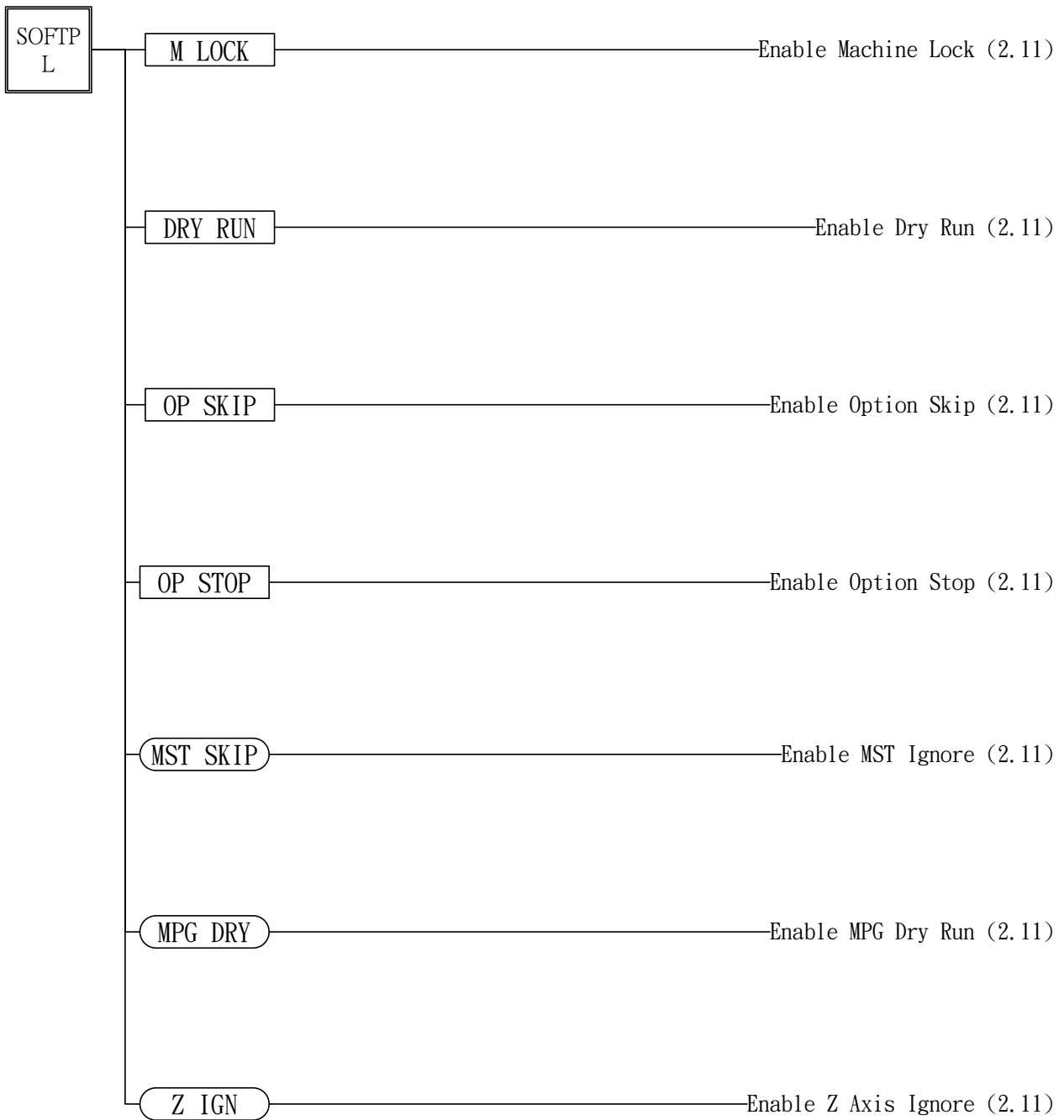

● **PARAM Function Key Tree Figure (Machine Maker)**

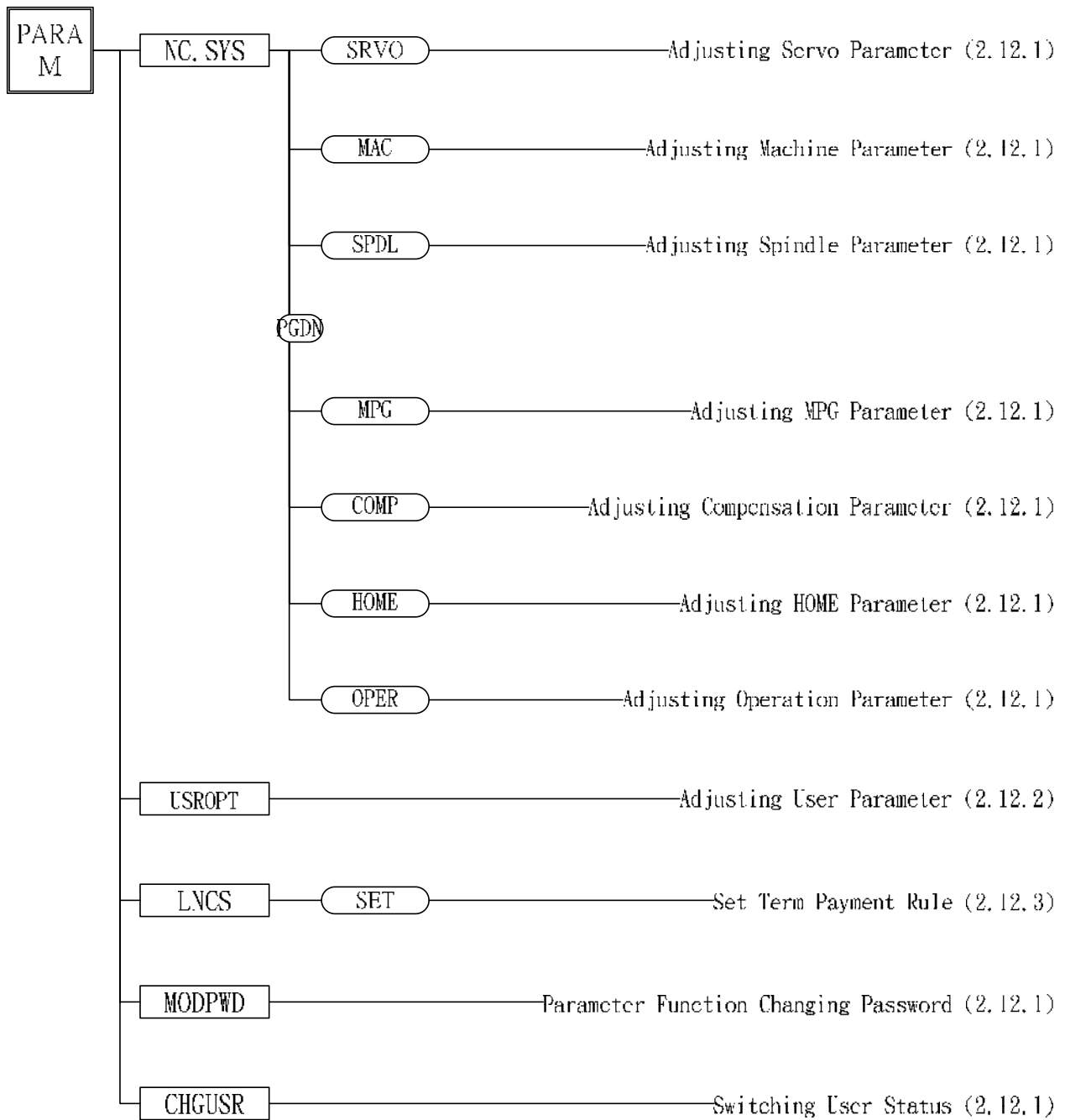

● **PARAM Function Key Tree Figure (End-User)**

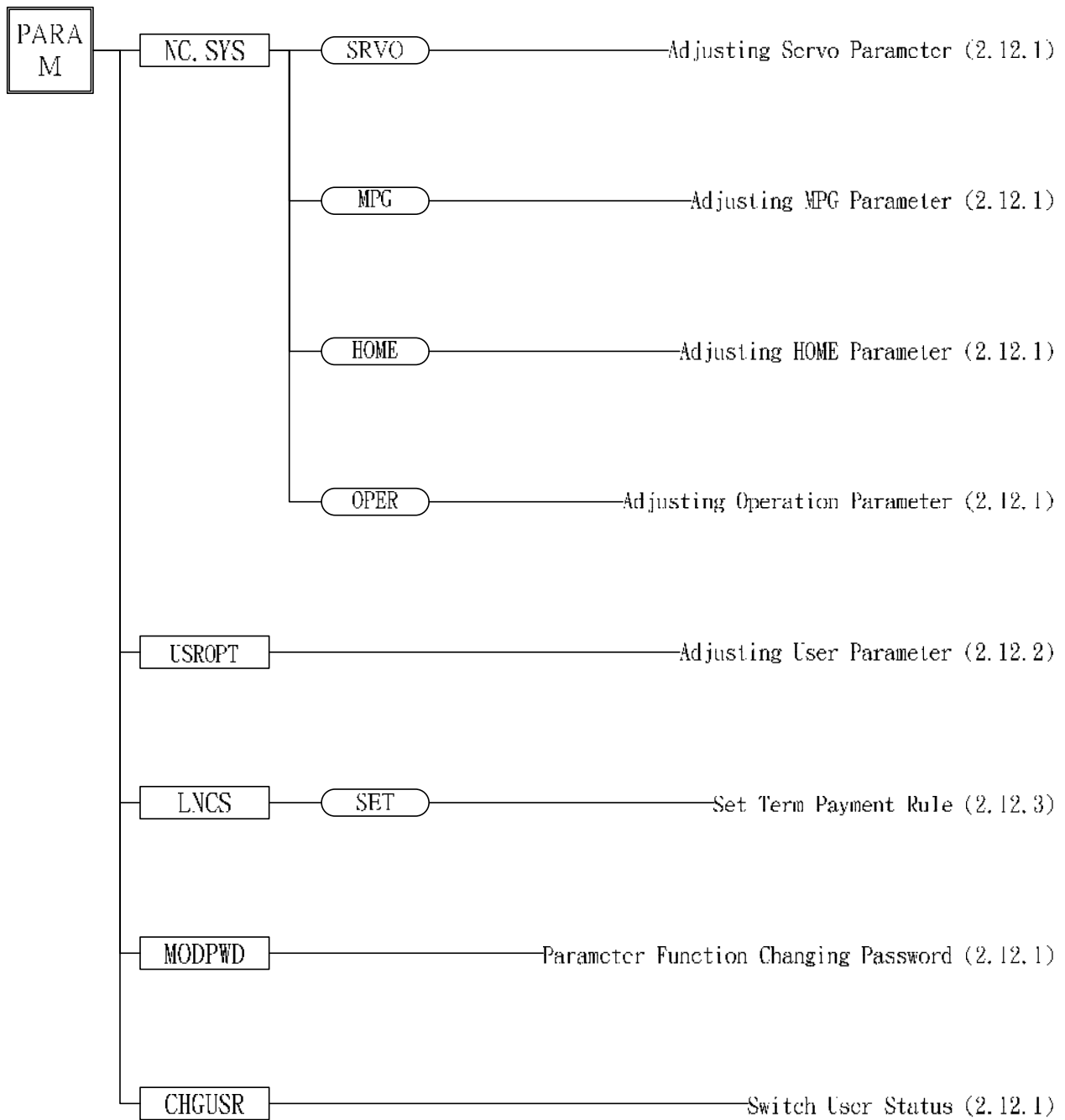

2.4 POS Function

Pressing <POS> key to enter into the coordinate display screen. There are 6 main function key selections for users. Users will be able to choose 6 screen displays by pressing those function keys which are **【ABS.】** , **【REL.】** , **【MAC.】** , **【RST】** and **【QUIT】** . There are some command information that will be displayed in those screens, which will be described separately as following:

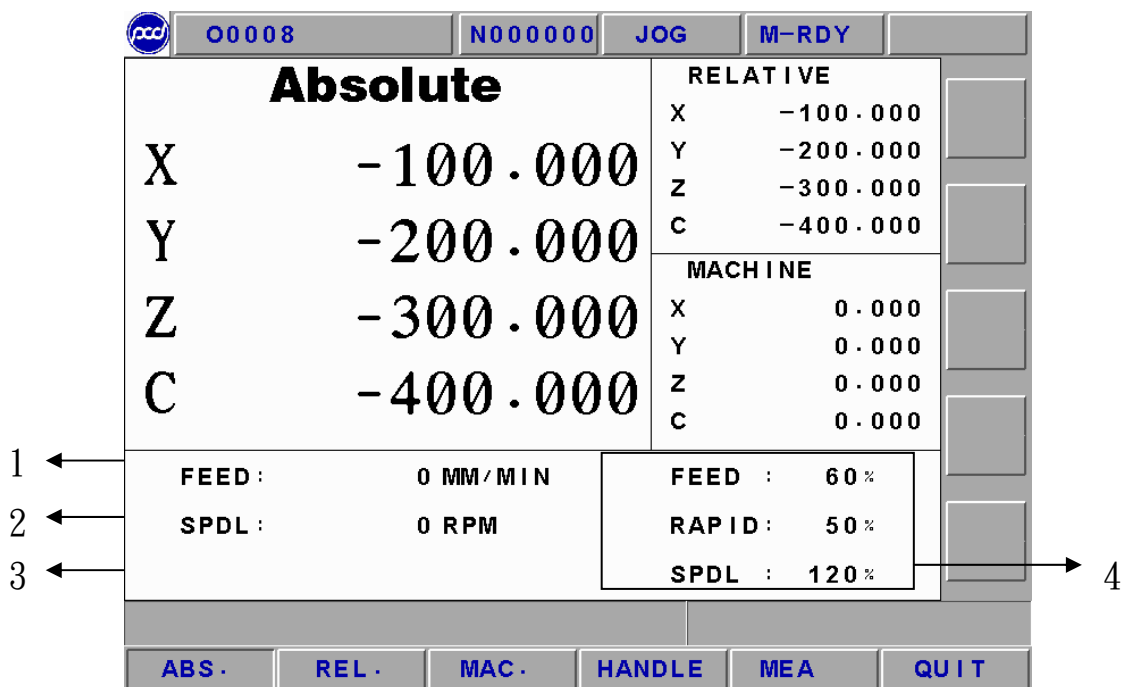

Figure 2.4-1 POS Function Display Screen

1. **Actual Feed Rate** : Feed rate of servo structure, the composite speed of 3 servo axes.
2. **Spindle Rotational Speed** : The actual spindle rotational speed at a certain time.
3. **Message Hint Row** : F0(Feedrate is 0), SBK(Single Block Executing), BDT(Optional Single Block Jump), DRN(Program Dry Run), MLK(Machine Lock), OPS (Optional Program Stop) and ABS (Absolute Encoder Reading) .
4. **Feedrate Condition** : Feedrate percentage, rapidly percentage, rotational percentage.

2.4.1 ABSOLUTE COORDINATE

Pressing **【ABS.】** to enter into absolute coordinate screen. Beside the absolute coordinate screen are sub-screens for **【REL】** , and **【MAC】** .

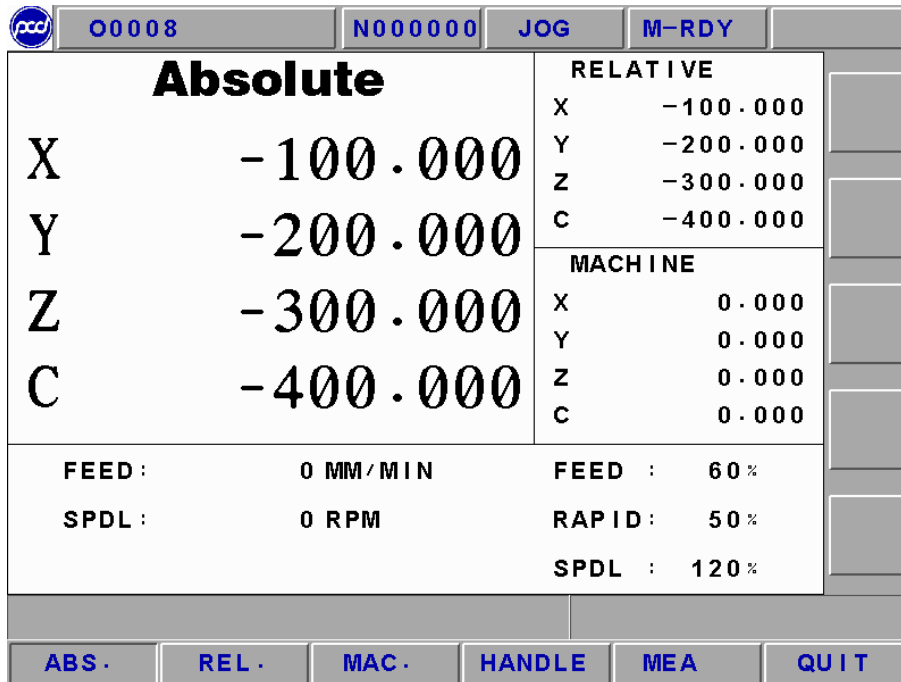

Figure 2.4-2 **【ABS.】** Screen

Absolute coordinate is the program coordinate, which is [present value – tool offset = program value.] This will display the present executing position of each axis minus each axis offset.

2.4.2 RELATIVE COORDINATE

Pressing **【REL.】** to enter into the relative coordinate screen. Beside the relative coordinate screen are sub-screens for **【ABS.】** and **【MAC.】**.

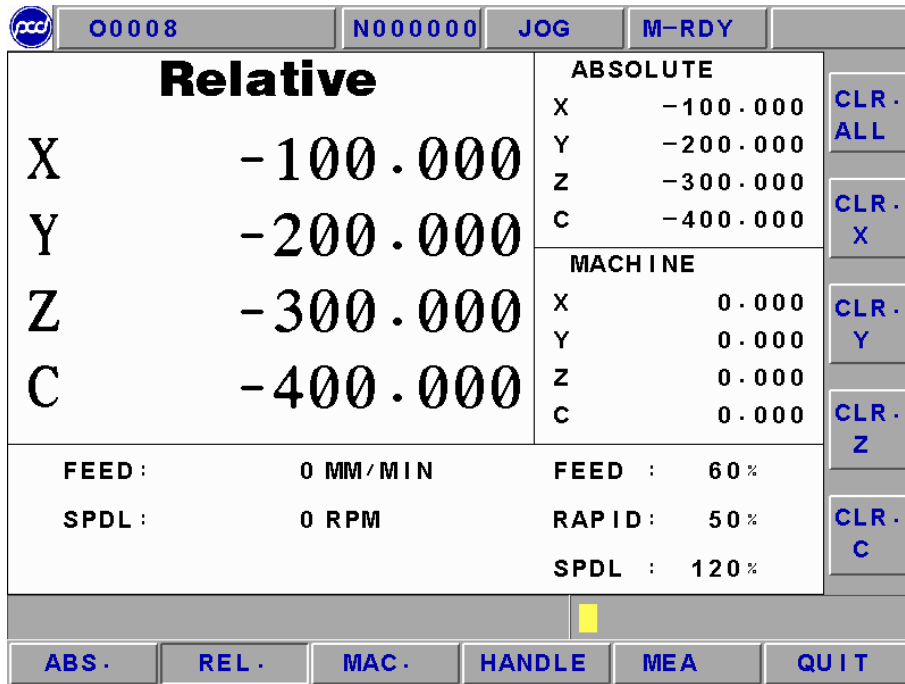

Figure 2.4-3 **【REL.】** Screen

The relative coordinate system means the distance between the present position and any point that is decided by users. So users can set the relative coordinate value to zero anytime, or enter the non-zero value directly.

If want to reset the coordinate value and to let X coordinate to 100.00, Y coordinate to 200.000 and Z coordinate to 300.000, only need to set X100, Y200, Z300. Then, pressing <INPUT> to reset the coordinate value immediately.

If want to set the 3 axes relative coordinate values to zero separately or at the same time, users only need to press the corresponding sub-function buttons **【CLR. X】**, **【CLR. Y】**, **【CLR. Z】**, **【CLR. ALL】** to execute the corresponding clean.

2.4.3 MACHINERY COORDINATE

Pressing **【MAC.】** to enter into the relative coordinate screen. Beside the machine coordinate screen are sub-screens for **【ABS.】** and **【REL.】**.

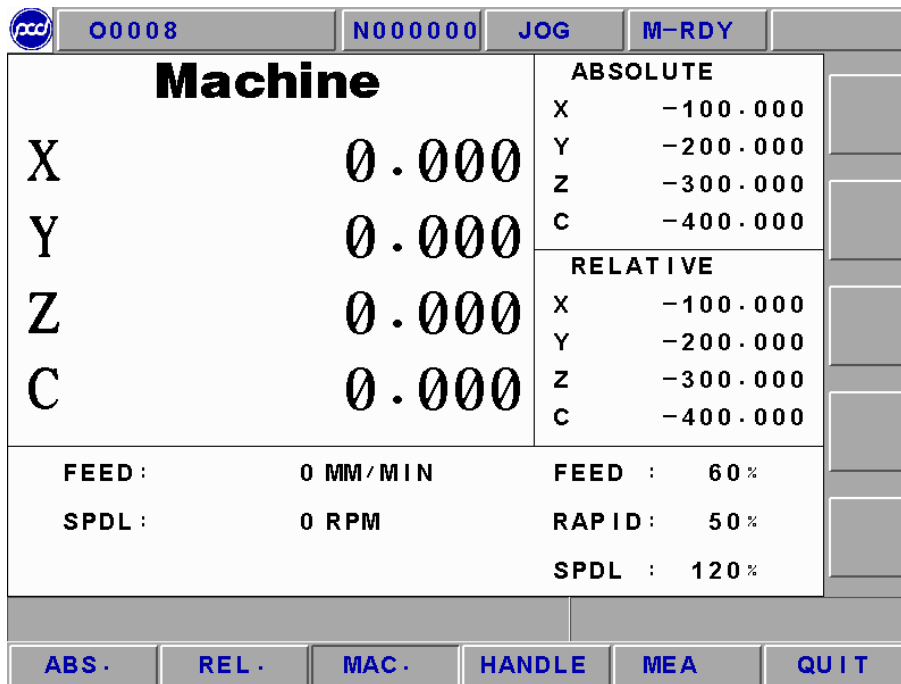

Figure 2.4-4 **【MAC.】** Screen

Machine coordinate is the distance of the present position corresponding to the reference point. Each machine has its own reference point. For safety concern, please looking for the reference point whenever reboot machine before executing work.

2.4.4 MEA (Measure)

For program reference point setting, this controller provides setting methods for two types of program coordinates. One of the methods is to enter the position of the machine coordinate program definition at the **[WORK]**. The second method is using G92 to define. This function page **[MEA]** is using the latter method, which is using the tool position to set the reference point of the new coordinate system. The original coordinate system will be the working coordinate system. Once set, the absolute value is refer to this coordinate system to calculate. This system provides the setting method like the above Figure.

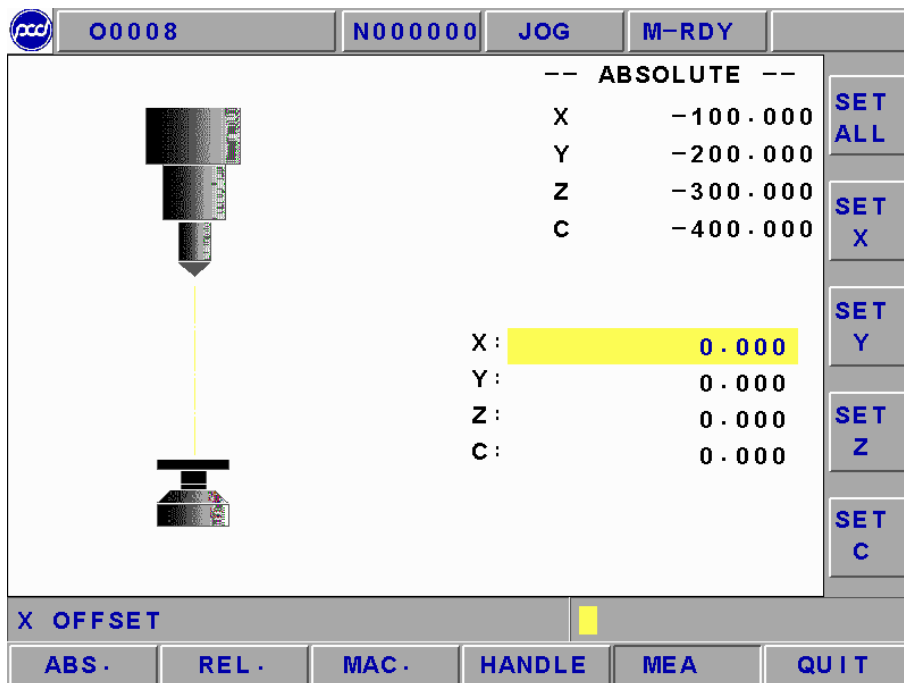

Figure 2.4-5 MEA Screen

[ALL SET] Using G92 to redefine X, Y, and Z axes absolute reference point position.

[SET X] Using G92 to set X axis absolute coordinate value to 0.

[SET Y] Using G92 to set Y axis absolute coordinate value to 0.

[SET Z] Using G92 to set Z axis absolute coordinate value to 0.

Example:

1. Moving tool to touch working part's surface.
2. Pressing **[SET Z]** , using G92 to set Z axis coordinate to 0. Re-define Z axis reference point of absolute coordinate.

Note: Must complete home return procedure before operating no matter using which method to reset coordinate system.

2.4.5 EXIT

Pressing **【EXIT】**function button to enter into code entry windows and key-in correct codes.
 Pressing **【OK】** key to exit CNC system and returning back to DOS system. Pressing **【CANCEL】** key to return back to program and to continue executing.

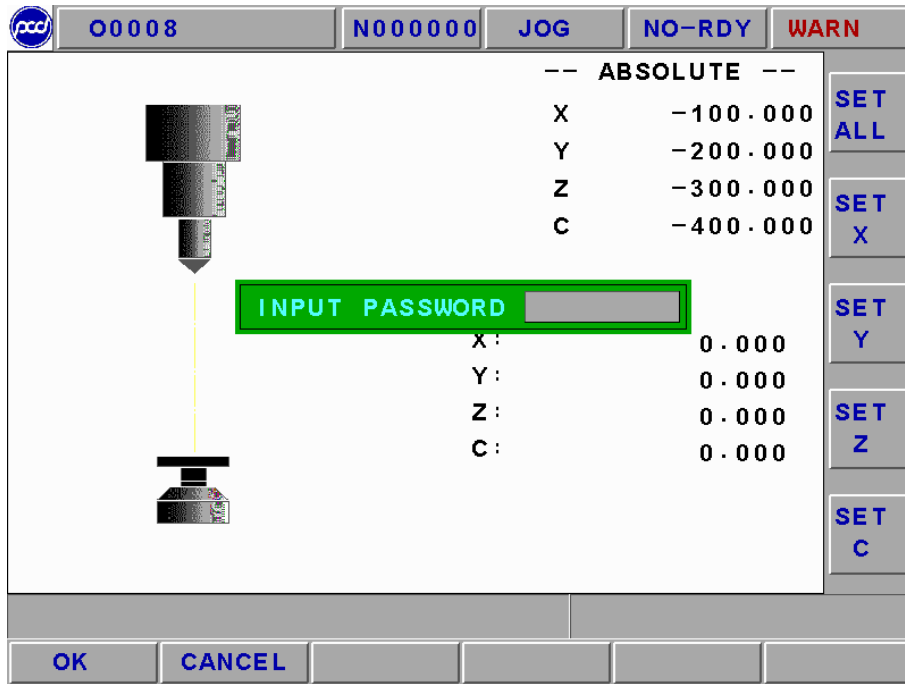

Figure 2.4-6 EXIT

2.5 PROG

Pressing <PROG> to enter into program function group screen. This function group provides part program editing, checking, file managing, RS232 transmitting and other related functions.

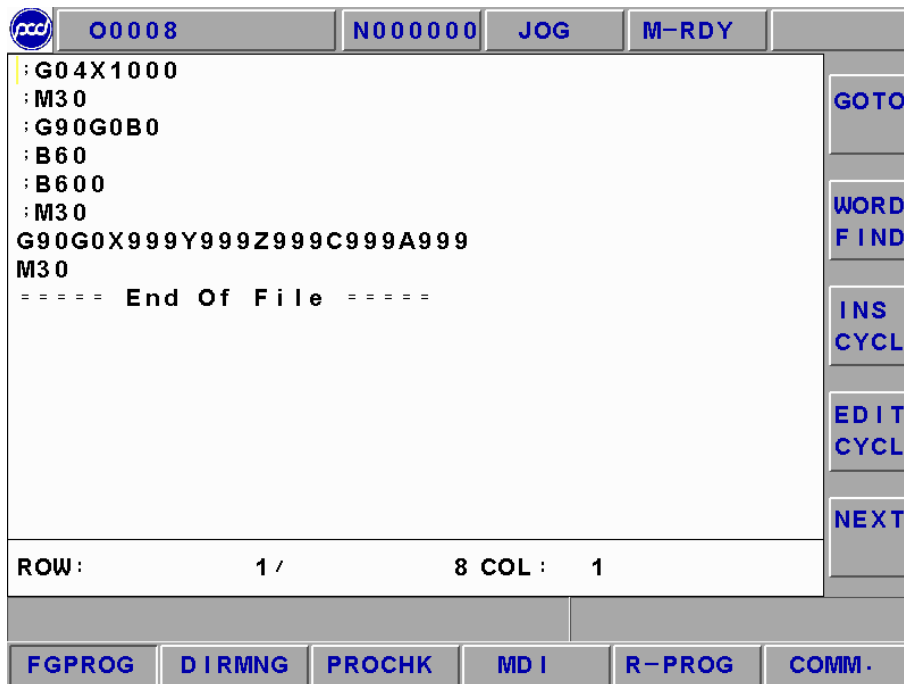

Figure 2.5-1 PROG Screen

2.5.1 FGPROG

Under editing condition, pressing **【FGPROG】** to display the program content of the current opened controller. At this time, using the sub-function button at the right side and the entering rows at the bottom of the screen to do the program editing.

- **【GO TO】** (Row Orientation)

Pressing **【GO TO】** function button at the right side to key-in "ROW" number of the program in the dialog box. Pressing **【INPUT】** to move the cursor to the assigned row orientation. Please refer to the below figure.

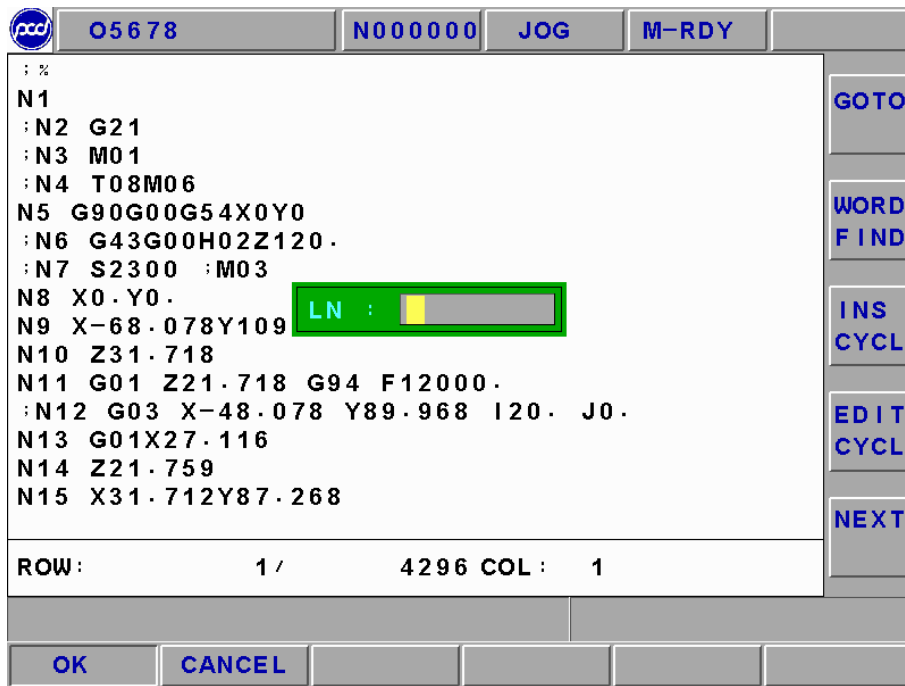

Figure 2.5-2 Row Orientation Page

Note: Not able to executing program enabling under editing mode.

● **【WORD FIND】**

Able to searching a specific block of characters.

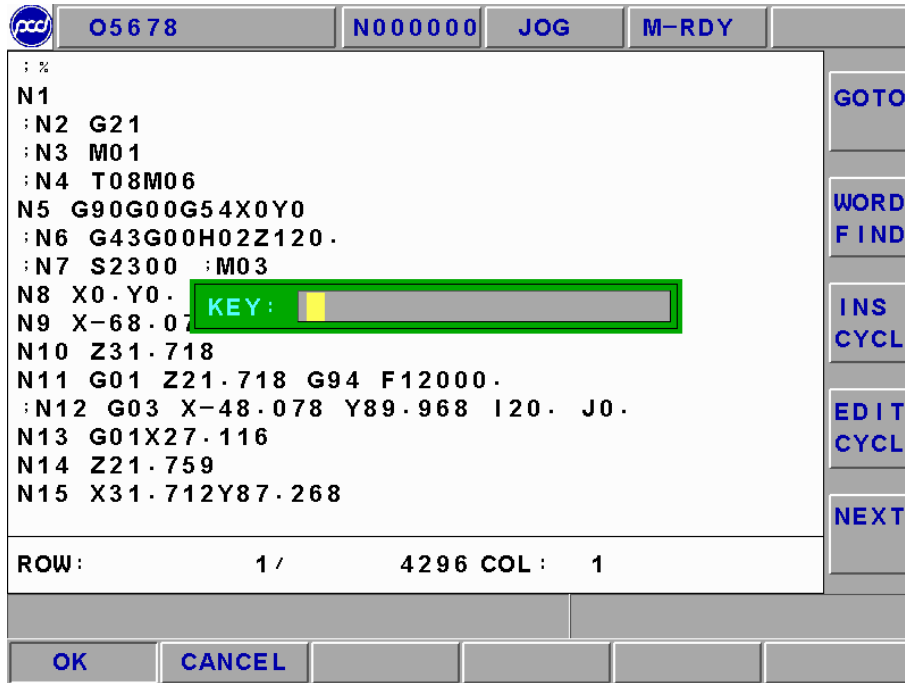

Figure 2.5-3 Searching Function Page

● **【INS CYCL】**

This function is to provide each working method in order to product program rapidly.



Figure 2.5-4 Insert Page-1

Pressing “Input” after selecting working method.

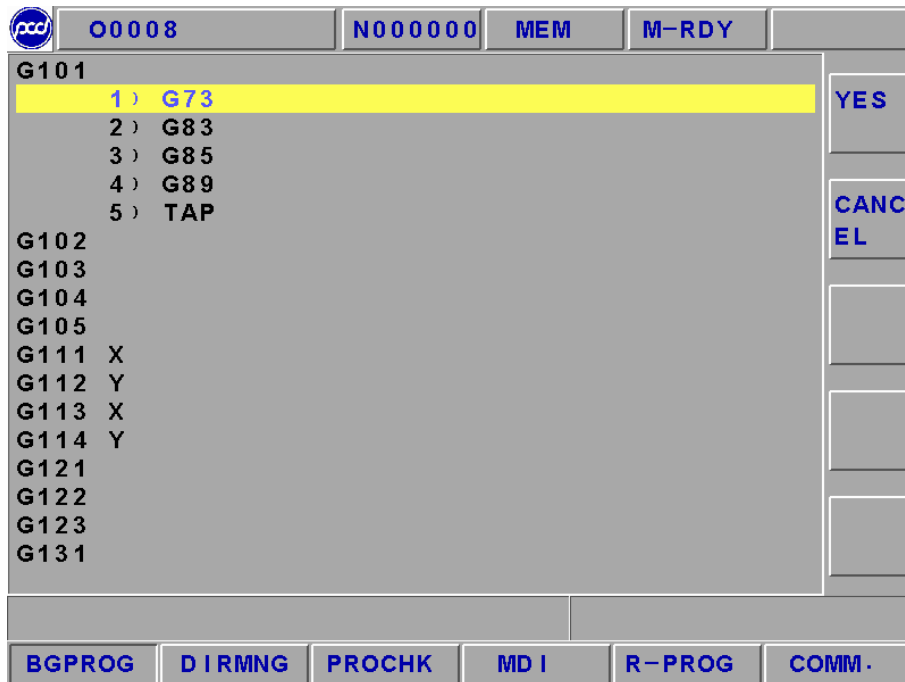

Figure 2.5-5 Insert Page-2

To press “Input” key to enter into the following Figure page. To move the highlighter to each parameter column and then press <INPUT> key.

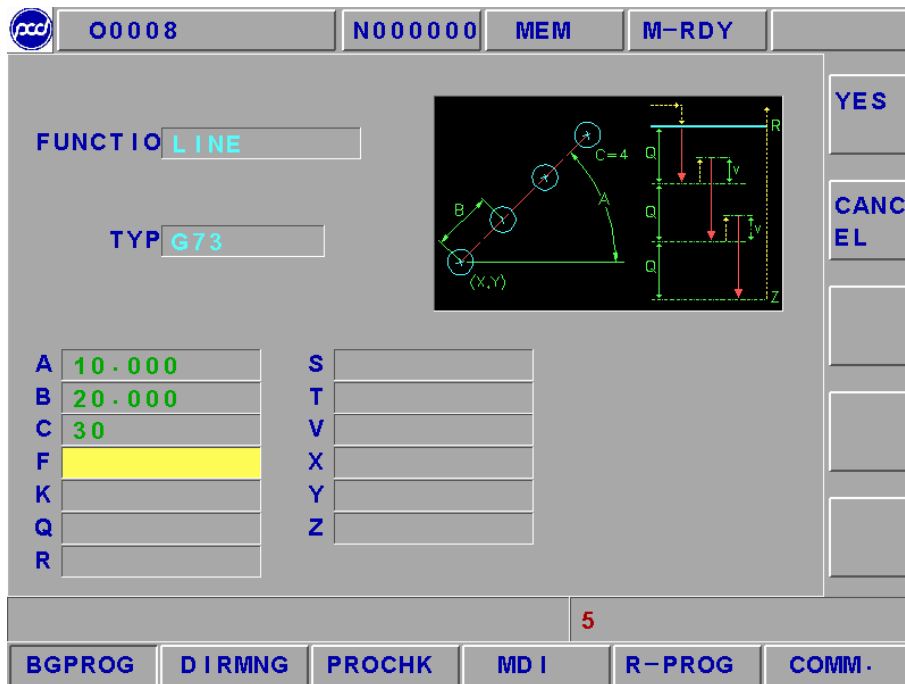

Figure 2.5-6 Insert Page-3

Program code page is as following after pressing 【OK】 .

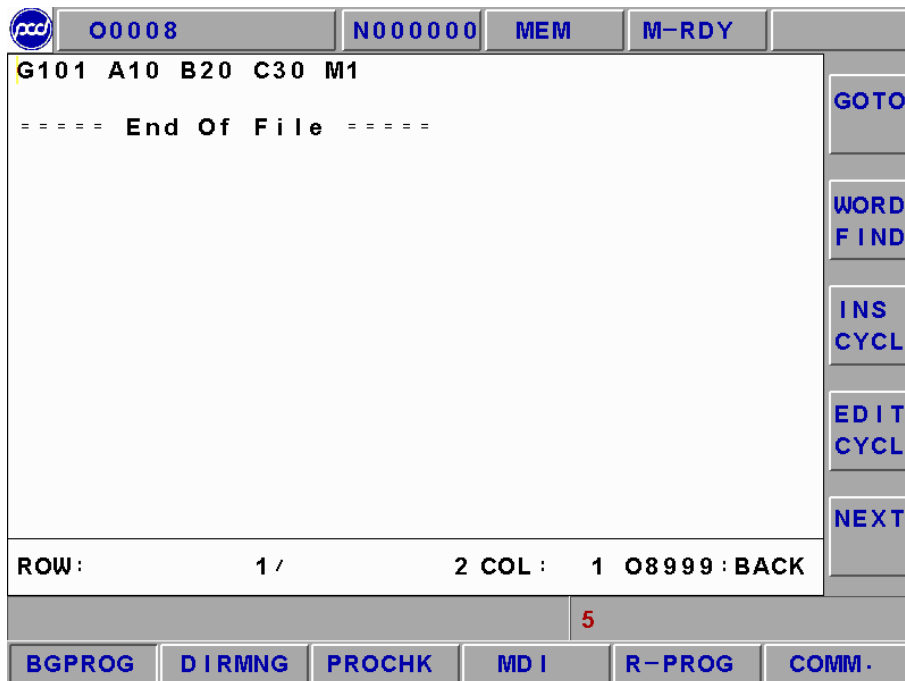

Figure 2.5-7 Program Code Page

- **【EDIT CYCL】**

This function key is effective when the editing cursor is stop at **【INS CYCL】** command block or there is G Code in that **【INS CYCL】** block. To press this key will enter into “Insert-3” page. If there is no assigned M Parameter (working style) value after G code, “Insert-2” page will occur.

- **【LDEL】 (Row Delete)**

Able to delete a row of program codes at the cursor position.

- **【MARK】**

Pressing **【MARK】** at the right side of the screen to move the cursor to the wanted marking row’s starting/ending point. Moving the cursor to the starting/ending position of the wanted marking row and pressing the **【MARK】** function key again to mark the designated marking rows. Please refer to the below figure.

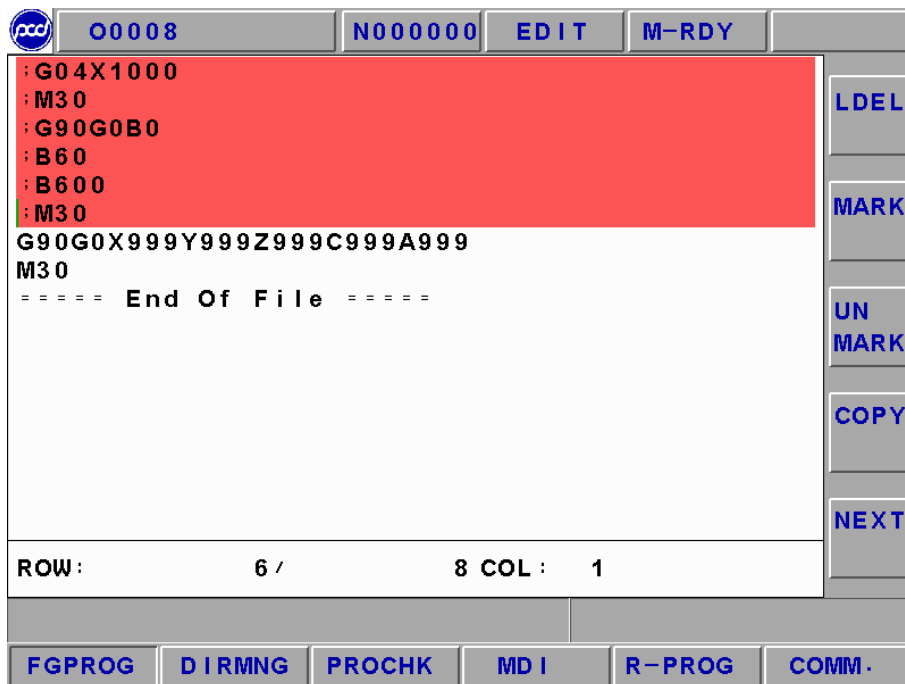

Figure 2.5-8 Marking Function Page

- **【UNMARK】**

To cancel previous marking sign.

- **【COPY】**

To copy the marked program in local range.

- **【CUT】**

To cut down the marked program in local range.

- **【BIND】**

To paste on the program codes that are copied or cut at previous time.

● **【THIN MODE】 / 【THIN CANC】**

Absolute coordinate, relative coordinate, and machine coordinate will be popup after pressing this key. Also, **【THIN INST】** will be popup at the right-hand side in order to provide user to current absolute coordinate.

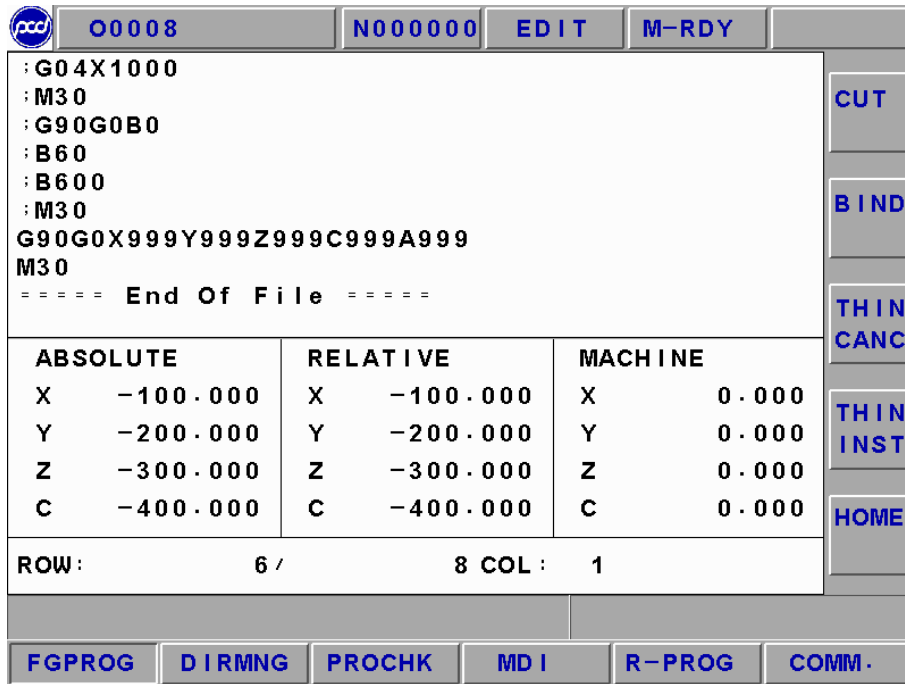

Figure 2.5-9 Teach-In Function Page

2.5.2 BGPROG (Background Program)

Pressing **【BGPROG】** to enter into background editing mode under auto mode. Background editing allows users to edit another part program while executing one part program in auto mode. Editing method and the environment of doing present program in editing mode are totally the same.

Note: Background file is 08999 permanently.

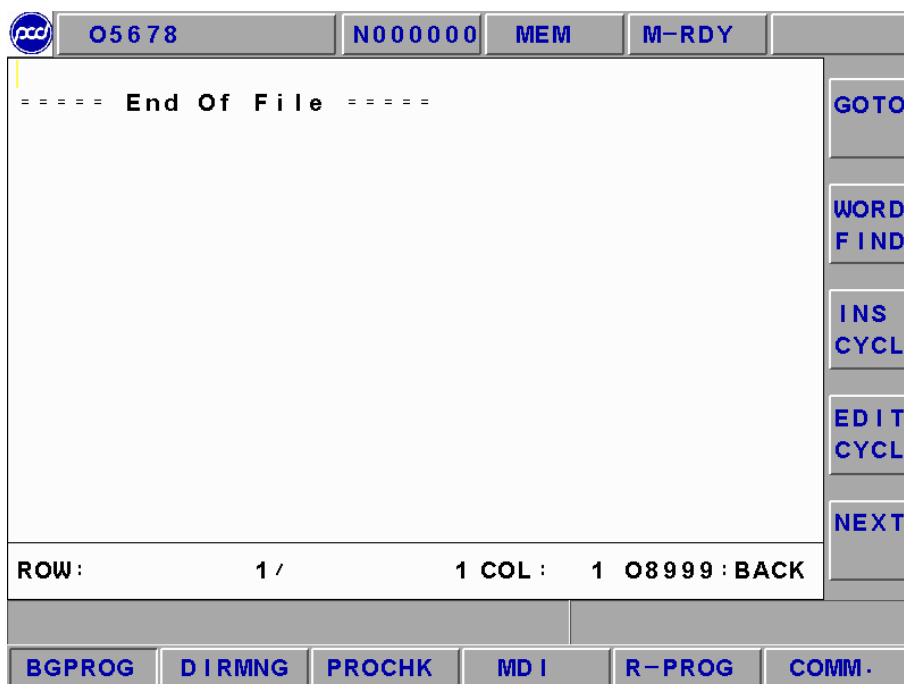

Figure 2.5-10 Background Editing Mode

2.5.3 DIRMNG (File Management)

In file management screen, system provides the related file opening, copying, deleting, renaming, and setting menu functions. A detailed description is as following.

- **【FILE】**

1. Able to use direction key to choose the wanted open file after entering into the file management screen. Also, users are able to open a file after pressing <INPUT>.
2. After pressing open file selection button, a dialog box will occur on the screen. Please choose or key-in the wanted open file name and then pressing <INPUT> to open the file.
3. The opened file is a background program under auto mode. Automatically setting the opened file to the present program under editing mode means NOT able to open the file under other modes.

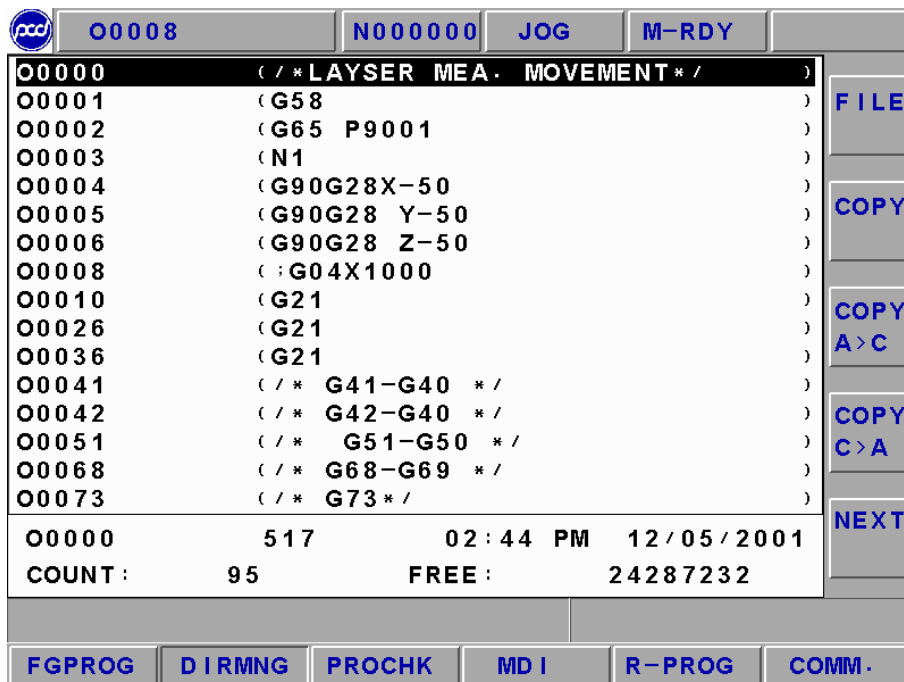

Figure 2.5-11 DIRMNG Screen

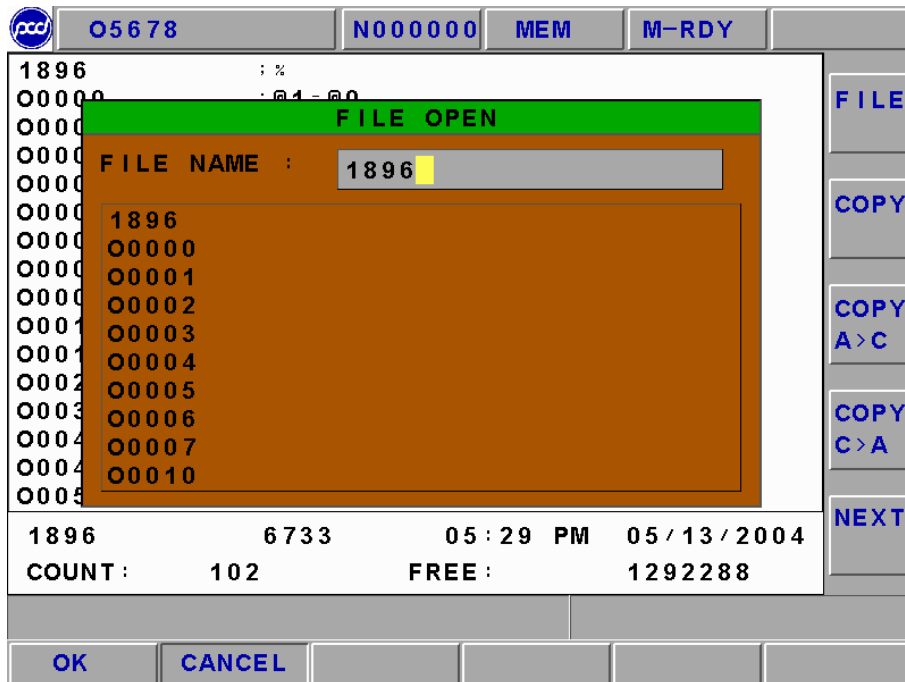

Figure 2.5-12 Screen of Pressing **【FILE】** Button

- **【COPY】**

A dialog box of file copying will occur on the screen by pressing copy button. Users are able to choose or enter the file's path or file name as the source file when copy files.

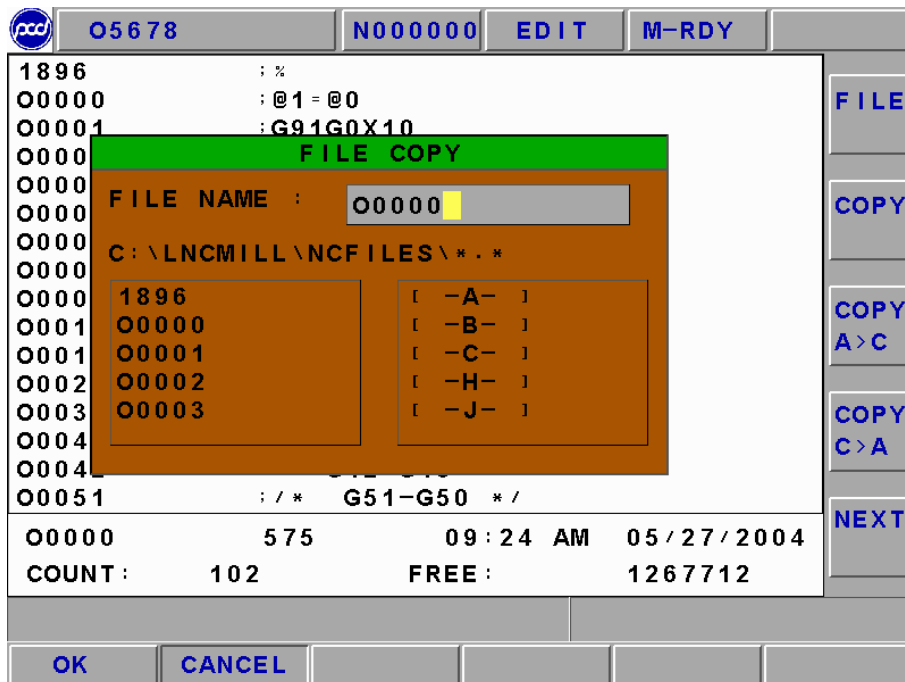

Figure 2.5-13 Screen of Pressing **【COPY】** Function Button

Able to enter the copied destination file name in the destination file column. If only enter file name, then the file path is the system default value.

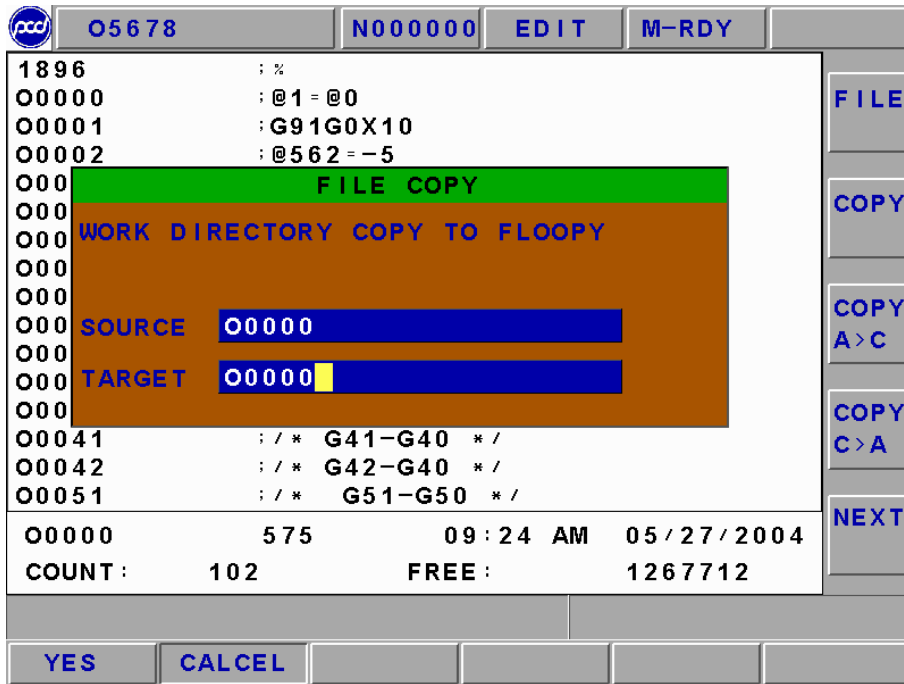

Figure 2.5-14 Screen of Key-In Destination File Name

If the file is already existed, then the reminding windows will occur. Please confirm if want to execute overwriting action.

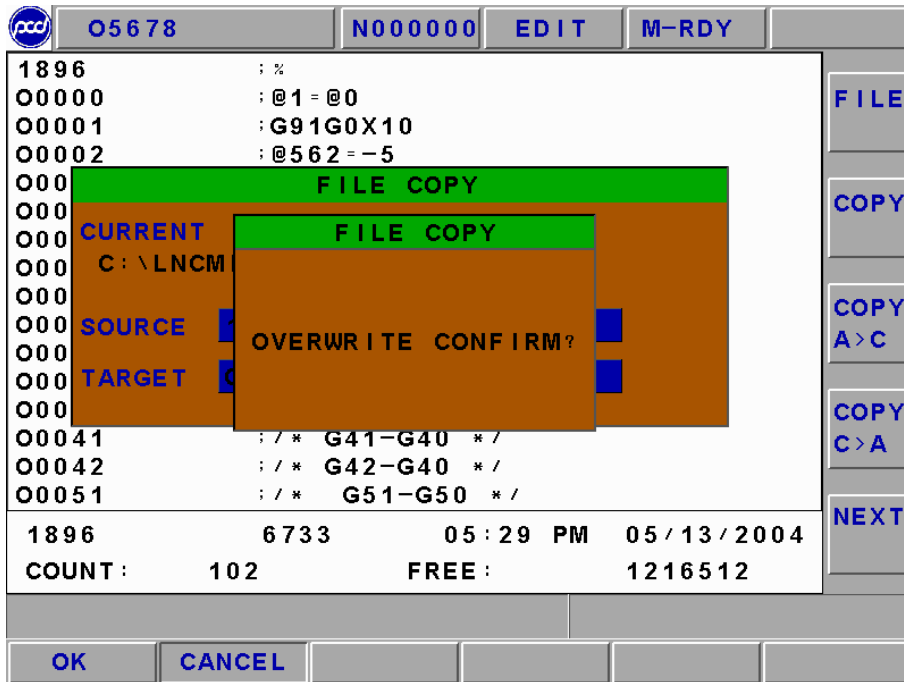

Figure 2.5-15 Screen When the Copied File is Already Existed

If the program is copying, the message-reminding dialog box will occur “Copying...”. When complete, the message-reminding dialog box will occur “Copy Complete”.

- **【COPY A>C】**

To copy from floppy drive (A drive) to CF card (C drive) function. Operation is like **【Copy】** .

- **【Copy C>A】**

To copy from CF card (C drive) to floppy drive (A drive) function. Operation is like **【Copy】** .

- **【DEL】**

Pressing on this sub-function button, a file delete dialog box will appear on the screen. Please choose the wanted delete file in that dialog box. After complete deleting, users can use Program Table to confirm.

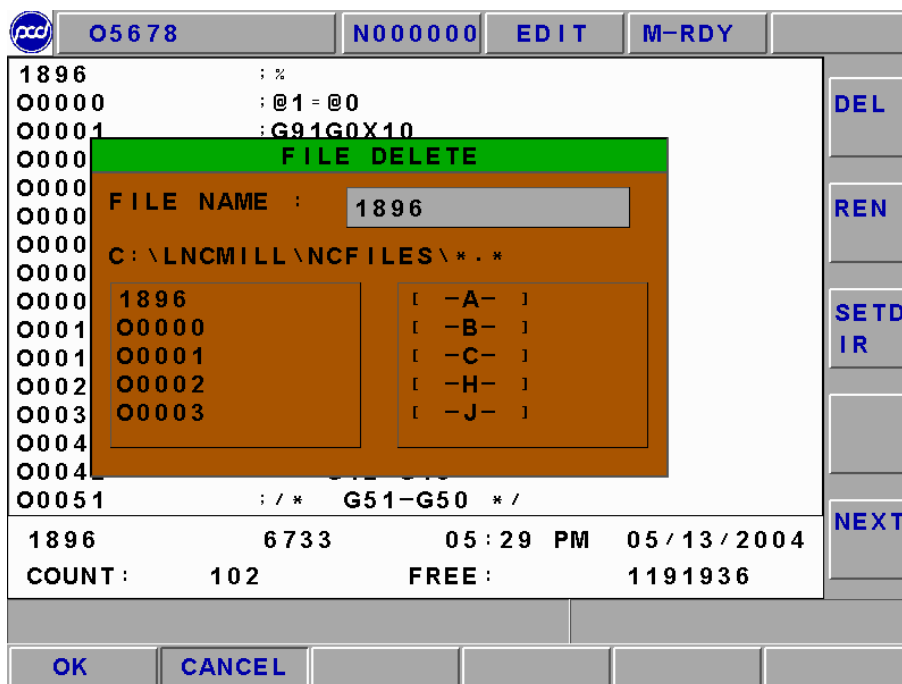

Figure 2.5-16 **【DEL】** Screen

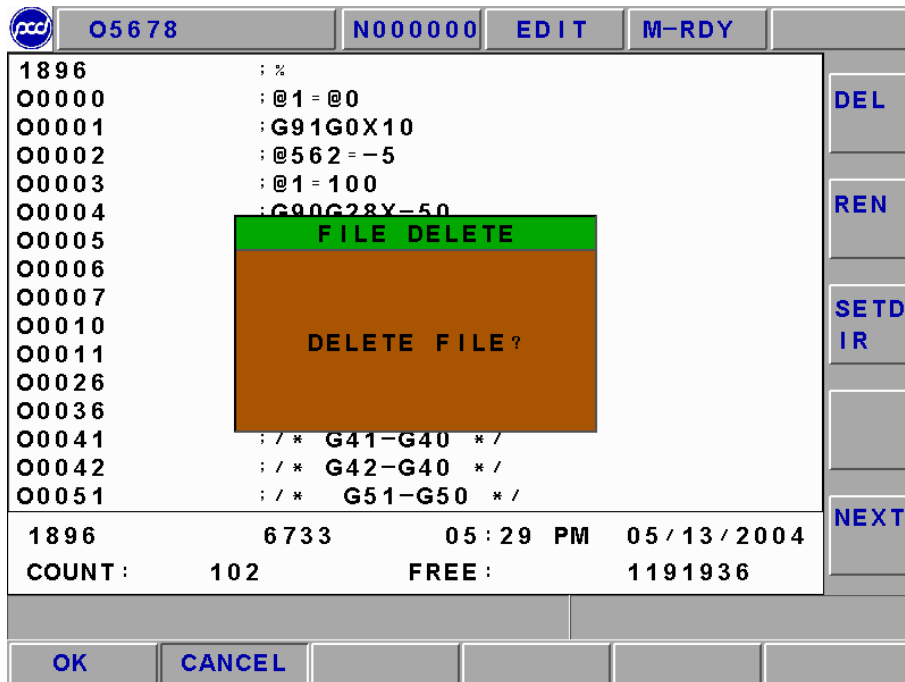

Figure 2.5-17 Double Confirm Deleting Page

● **【REN】**

1. After pressing rename function button, a rename file source windows will occur on the screen. Users are able to choose the wanted change's file name. Pressing confirm button to enter into the file rename windows.
2. To enter the destination file name in the rename windows and then to press confirm button. After rename complete, users will be able to use program list to confirm.

● 【DIR SET】

A dialog box of part program menu setting will occur on the screen by pressing this sub-function button. Users are able to set the part program menu by using this dialog box or by entering work path directly.

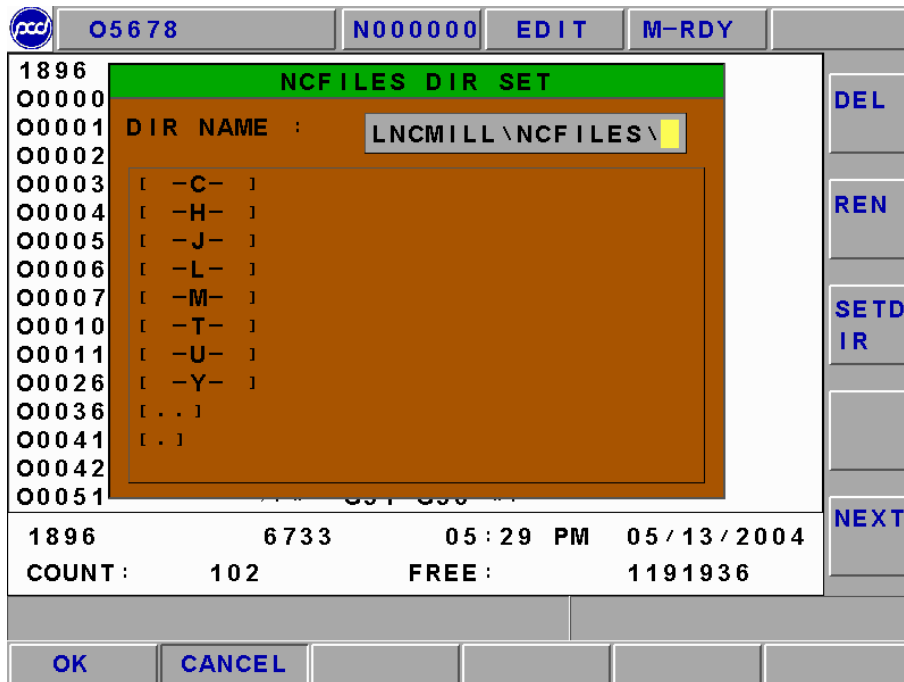

Figure 2.5-18 Screen when Setting Part Program Menu

2.5.4 PROCHK (Program Checking)

Under auto mode, pressing **【PROCHK】** function buttons to enter into the automatic program checking screen as below figure. Sub-function buttons, at right side of the screen, provide checking options.

【CUR】 To display data information of the present executing single block.

【NEXT】 To display data information of the next single block

【CHK】 The upper half of the main screen will display program content and the present executing program will be highlighted. The bottom half has coordinate values, M/S/G/T codes present value, actual speed display and etc.

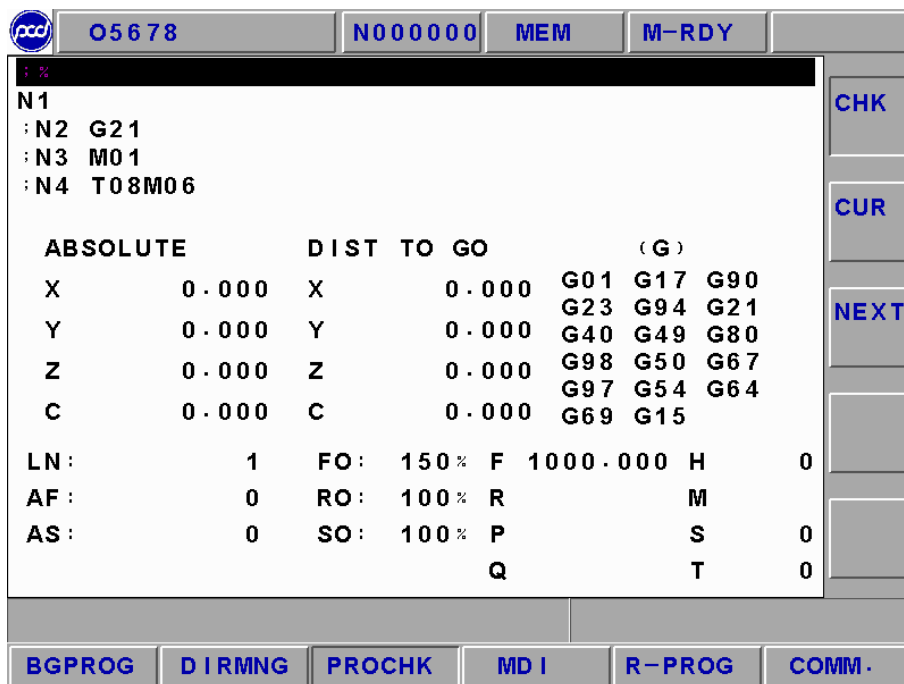

Figure 2.5-19 **【PROCHK】** Screen

2.5.5 MDI

Pressing **【MDI】** key to entry into MDI page under MDI mode. User is to key-in a single command block and then press <INPUT>. Then, the command will occur at the left section of the main page. Then, pressing Cycle Start key and the command will be executed and related data will be displayed. Using this method to do test running is more safe and more time-efficiency.

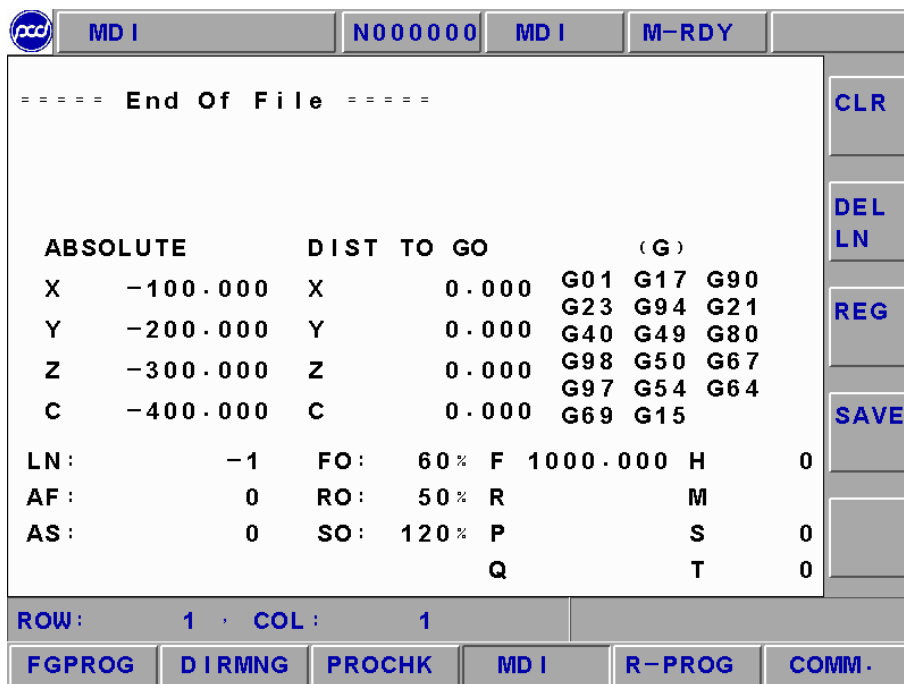

Figure 2.5-20 MDI Page

2.5.6 COMM (Communication of Files (RS232))

Clicking the **【COMM】** function button to receive and transmit programs between the controller and other PCs. Operation and description of sub-function buttons **【COMM】** and **【SETT】** are as following.

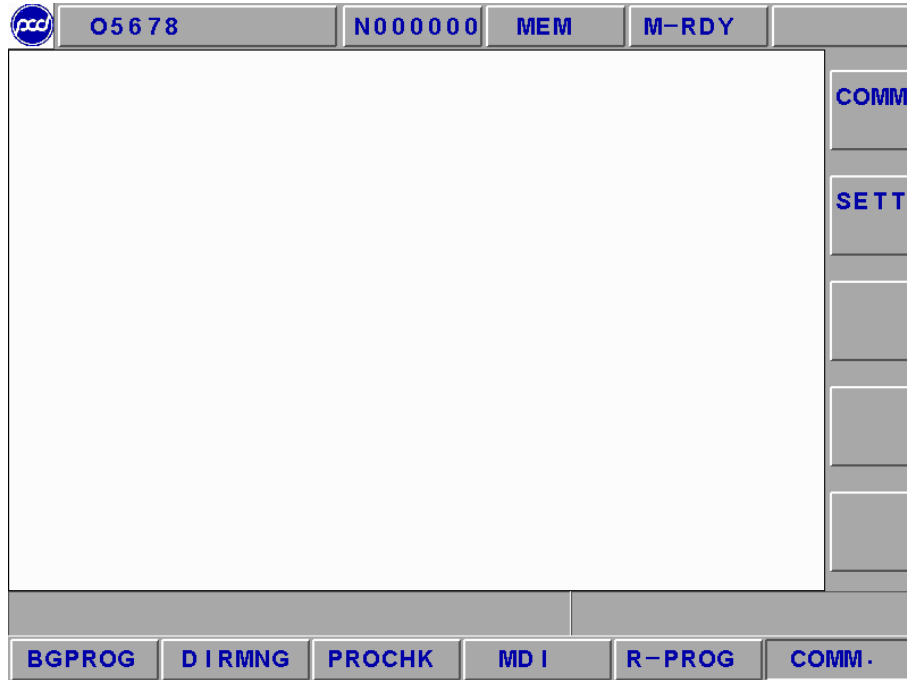

Figure 2.5-21 **【COMM】** Screen

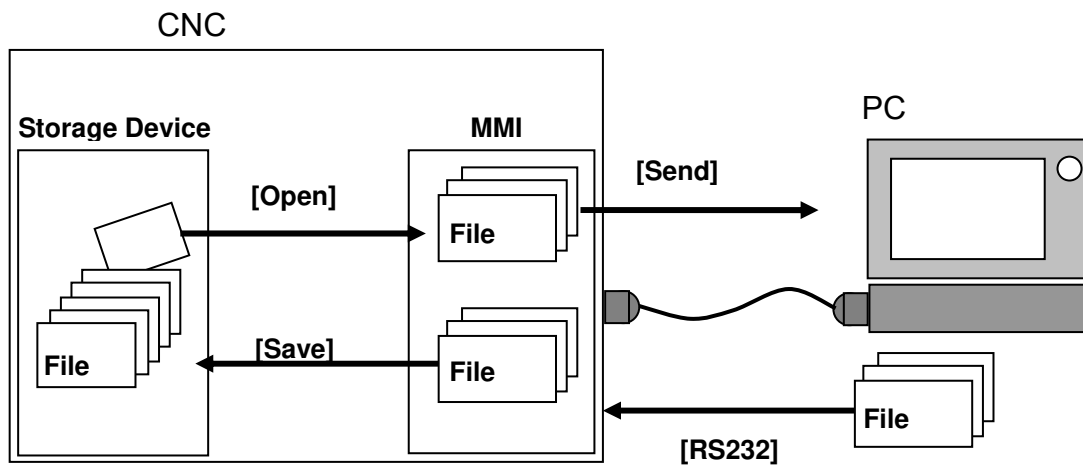

Figure 2.5-22 Files Transmitting/Receiving Figure between Controller and Other PCs

- **【Comm.】** (Communication)

Users are able to executing RS-232 file transmitting (DNC), reading, saving, resetting and other operations. Before using RS232 function, please confirm whether or not the hardware connection is correct. Also, the setting of RS232 protocol and remote device must be the same.

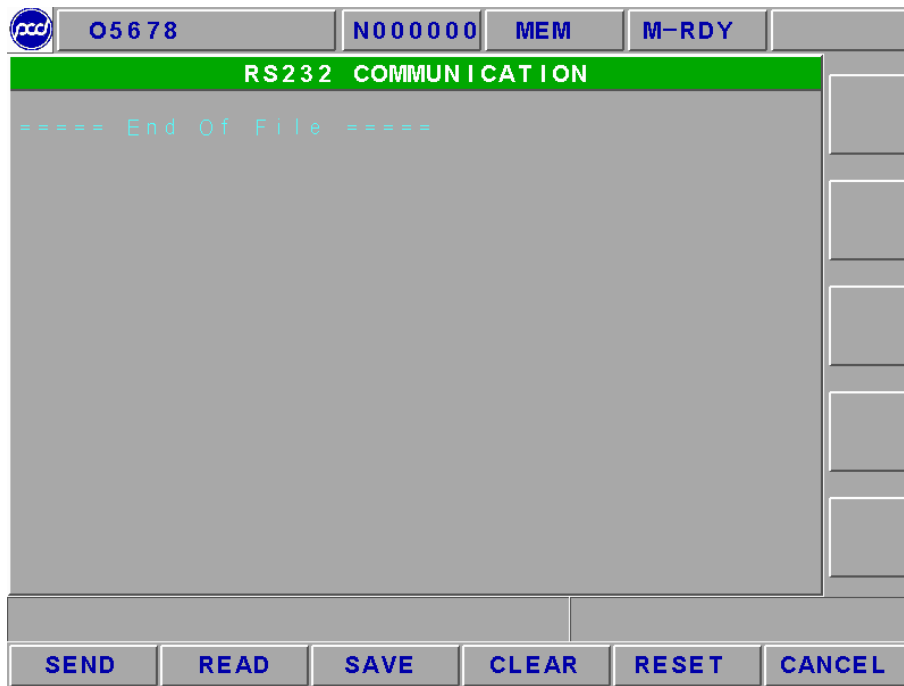

Figure 2.5-23 File Transmitting Page

【SEND】

Users are able to executing RS-232 file transmitting (DNC), reading, saving, resetting and other operations. Before using RS232 function, please confirm whether or not the hardware connection is correct. Also, the setting of RS232 transmitting protocol and remote device must be the same.



Figure 2.5-24 Selecting File Transmitting Function Page

【READ】

Before PC starts transmitting, must pressing this function key in order to let the system to prepare to receive data.

【SAVE AS】

When transmitting one program file to RS232 of the controller's windows from outside, pressing this key to select/key-in the storage path or file name directly.



Figure 2.5-25 Save File Function Page

【CLEAR】

Giving up and clearing program files in the windows.

【RESET】

Giving up file transmitting and resetting communication deal in order to build up connect with RS232.

● **【RS232】**

This screen provides the module setting of **RS232**. The setting at each side of the **RS232** transmitting must be correct and the same in order to transmit (or so call DNC function) correctly. Users are able to modify the transmitting deal for **RS232** on this screen.

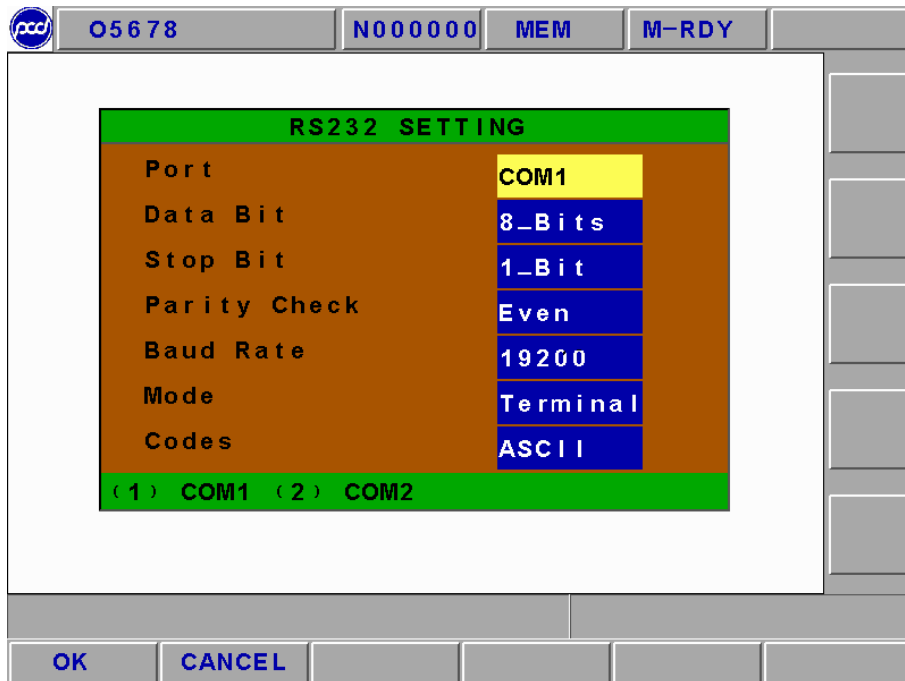

Figure 2.5-26 RS232 Setting

2.5.7 DNC Function

DNC function is a very useful function for CAD/CAM system users, especially the controller is the controller used only (not the controller of PC BASED). Since the storage memory capacity is not very big, so not possible to download all the programs at once, which implies that it is very important for the DNC function to do its function while transmitting. Since DNC program is doing its function while transmitting, so the controller can't edit it, neither using program calling nor using jump commanding. Pou Yuen already installed high capacity hard drive, therefore, users can transmit files into the hard drive and then execute those files (this method is called the internal DNC method.) The DNC function of executing its functions while transmitting is the other DNC method (this method is called the external DNC method.) The above methods are very convenience to use. The procedure is as below:

1. To set Controller and external PC as RS232 modal and to set the communication protocol the same
2. To switch to EDIT mode
3. To press function button **[COMM]** in order to enable file windows and to set file name as RS232
4. To switch to AUTO mode
5. To press "CYCLE START" button on OP Panel in order to transmit CNC waiting program
6. To enable external PC to do RS232 file transmitting
7. To execute machine work automatically

2.6 OFFSET

Pressing <OFFSET> to enter into the offset function screens such as **【TL. OFF】**, **【MACRO】**, and **【WORK】**. Users are able to modify these settings under MDI mode or machine ready mode.

2.6.1 TOOL OFFSET

Pressing **【TL. OFF】** to enter into the below screen (Figure 2.6-1) and to key-in data manually under MDI mode.

1. 30 sets of setting for Tool Offset. To switch the setting screen by using <PAGE ↓ > and <PAGE ↑ > keys.
2. To move highlighter on the wanted setting numbers. To key-in the setting value in the data enter rows and then to press <INPUT> key to write into the controller.
3. Absolute coordinate will change with tool offset everytime the part program uses one tool offset number. The value is:

O0008		N000000		MEM	M-RDY
NO.	LENGTH	RADIUS	NO.	LENGTH	RADIUS
01	100.000	0.000	11	0.000	0.000
02	200.000	0.000	12	0.000	0.000
03	150.000	0.000	13	0.000	0.000
04	110.000	0.000	14	0.000	0.000
05	123.000	0.000	15	0.000	0.000
06	102.000	0.000	16	0.000	0.000
07	111.000	0.000	17	0.000	0.000
08	118.000	0.000	18	0.000	0.000
09	120.000	0.000	19	0.000	0.000
10	150.000	0.000	20	0.000	0.000
INPUT: ABS		UNIT: MM		--PAGE: 1 / 5--	
RELATIVE			MACHINE		
X	-100.000		X	0.000	
Y	-200.000		Y	0.000	
Z	-300.000		Z	0.000	
C	-400.000		C	0.000	
TL. OFF MACRO WORK TOOL					

Figure 2.6-1 TL. OFF Screen

2.6.2 MACRO

Pressing **[MACRO]** button to enter into the MACRO variable screen. In this function, variables can be entered or modified. The modification method is to move the highlighter to the wanted modify position and then to press <INPUT> key after entering the wanted value. Variables that start with L are local variables and those start with C are common variables. Please refer to MACRO chapter of program manual for a detailed description.

O0008		N000000		MEM	M-RDY
NUM	VALUE	NUM	VALUE		
L001	VACANT	L011	VACANT		
L002	VACANT	L012	VACANT		
L003	VACANT	L013	VACANT		
L004	VACANT	L014	VACANT		
L005	VACANT	L015	VACANT		
L006	VACANT	L016	VACANT		
L007	VACANT	L017	VACANT		
L008	VACANT	L018	VACANT		
L009	VACANT	L019	VACANT		
L010	VACANT	L020	VACANT		
--PAGE: 1 / 27--					
RELATIVE			MACHINE		
X	-100.000	X	0.000		
Y	-200.000	Y	0.000		
Z	-300.000	Z	0.000		
C	-400.000	C	0.000		
█					
TL-OFF	MACRO	WORK			TOOL

Figure 2.6-2 Local Variables of MACRO Variables

2.6.3 WORK

Pressing **【WORK】** button to enter into the working coordinate setting screen. In this function, moving the highlighter to the wanted modify position and following the below operation steps to execute setting.

Extend OFFSET setting will directly affect other 6 coordinate systems (G54 to G59). When setting, please consider work piece coordinate, tool and program executing relationships.

01: G54 machine coordinate value of the reference point = #01 setting value + #(00) setting value

02: G55 machine coordinate value of the reference point = #02 setting value + #(00) setting value

03: G56 machine coordinate value of the reference point = #03 setting value + #(00) setting value

04: G57 machine coordinate value of the reference point = #04 setting value + #(00) setting value

05: G58 machine coordinate value of the reference point = #08 setting value + #(00) setting value

06: G59 machine coordinate value of the reference point = #06 setting value + #(00) setting value

1. The controller will provide 7 sets of working coordinate system. Under MDI mode, users can execute the following settings such as G54, G5, G56, G57, G58 and G59. Also, using <PAGE ↓ > and <PAGE ↓ > key to switch screen.
2. Using direction keys to move cursor to the wanted change column and to key-in the setting value Xxxx (i.e. : X100 or Z200) in the enter rows. Then, the selected coordinate value will be updated immediately by pressing <INPUT> key.
3. Key-in the axis name and the new coordinate value, users are able to write 3 axes continuously. But, remember to put decimal point in order to prevent confusion. (i.e., X100. Z200.)
4. Set in the auto coordinate-gathering when the cursor is at G54~G59. So able to set the present machine coordinate automatically in the part coordinate setting page:

SET X : Teaching in the X-axis machine coordinate value directly on the work coordinate system where the cursor occurs.

SET Y : Teaching in the Y-axis machine coordinate value directly on the work coordinate system where the cursor occurs.

SET Z : Teaching in the Z-axis machine coordinate value directly on the work coordinate system where the cursor occurs.

SET ALL : Teaching in the three axes machine coordinate value of the present machine on the work coordinate system where the cursor occurs.

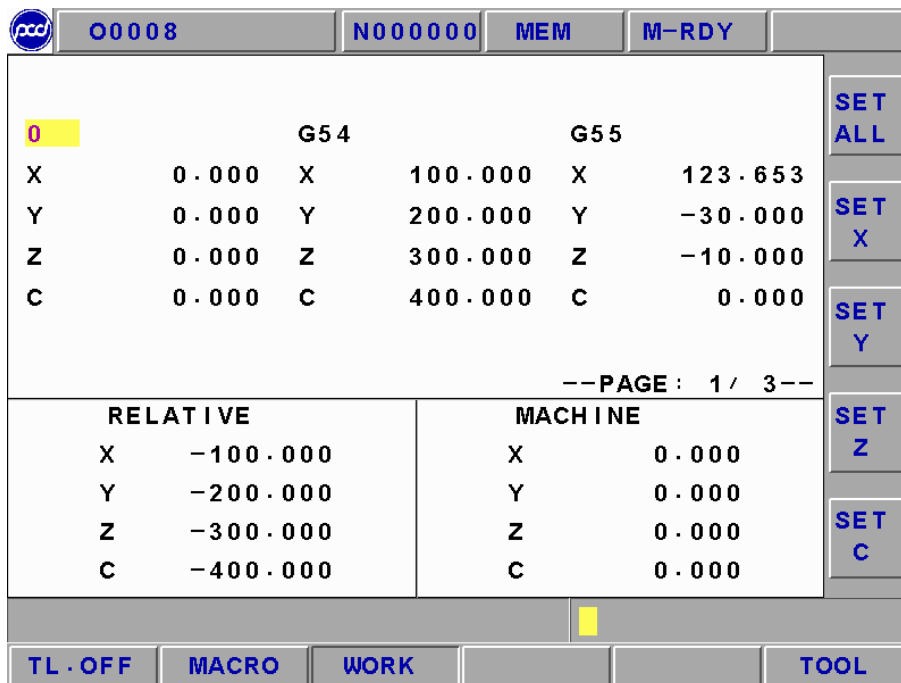

Figure 2.6-3 Working Coordinate Setting Screen

2.7 Milling EASY-CAM

2.7.1 Preface

This function provides 2D pocketing work of one allowable island. The function area has 「Rough-Cutting」 and 「Fine-Cutting」 working types. The CAM function in this controller allows users to produce auto NC path for its pocketing of any Profile shape. It means that it can define working piece's geometry shape direction on the controller. Also, it will produce the corresponding post NC code after setting the related working parameters.

2.7.2 Function Specification

Since this is a CAM system that is built inside the controller. In order to get the actual balance of the calculation efficiency of the specification, there are some using restrictions as below:

- Only allow defining one closed Profile and it is limited inside the closed Profile. Only can define maximum 6 islands.
- The line/arch's number of elements that are made by a single close profile and island cannot be more than 100 sections.
- Elements that are combined by Profile and Island must be closed.
- Island must be surrounding by Profile. So, the island must be defined with the Profile.
- Cannot have any intersect or self-intersect between islands. Also, cannot have any point or line connecting/cutting between islands.
- For profile and island, neither can have intersection nor have connection/cutting between them.
- The using pocking calculation method—Horizontal Surrounding (Arachnoids) . As the below figure.

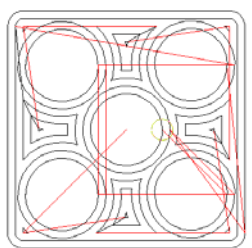

Figure 2.7-1 Pocketing Calculation Method—Horizontal Surrounding

2.7.3 CUT PAR (Cutting Parameter)

For this CAM function, able to get the correct path program as long as the cutting parameter setting is correct before path motion is executing. The definition of each parameter is described below:

- **Starting Surface** : The absolute Z coordinate program, which is used to assign the starting cutting level.
- **Ending Surface** : The absolute Z coordinate program, which is used to assign the ending cutting level.
- **Cutting Width**: Everytime's feed amount on XY pane for the assigned tool. This value should not be larger than the tool diameter.
- **Fine-Cutting Preservation Amount**: the preservation amount for already-formed size (for fine mill-cutting).
- **Feed Height** : The absolute Z coordinate program, which is use to set the starting point of mill-cutting. Tool will cut working part in G01 speed after arriving to the point in G00 speed. So, the setting value of that point must be greater than [Starting Surface].
- **Moving Height** : The absolute Z coordinate program, which is to set the ascent height when tool working is switching position during mill-cutting procedure. Tool will cut into the working part in G01 speed after arriving to the point in G00 speed. So the setting value of this point must be greater than [Starting Surface].
- **Tool Diameter**: This value must be greater than zero.
- **Tool Number**: The timing codes (M06 T) when the designated tool is doing tool-exchanging job, i.e., if this value is 1, M06 T01 will be produced.

- **Tool Length Offset** : To choose tool length offset, setting 0 means to use the +ive direction offset G43; setting 1 means to use –ive direction offset G44.
- **Offset Number** : When tool offset, H machine structure is the replace code.
- **Spindle Rotational Speed** : S machine structure means spindle rotational speed.
- **Flat Feed** : F machine structure, define tool's cutting feed rate is F when flat cutting.
- **Z-axis feedrate**: F machine structure, is to define the cutting feedrate is F when cutting toward Z-direction.
- **Climb/Conventional Cutting**: To decide the cutting type of the tool path program. Two cutting types are [Climb] and [Conventional]. [Climb] is used in rough-cutting and [Conventional] is used in smooth-cutting.

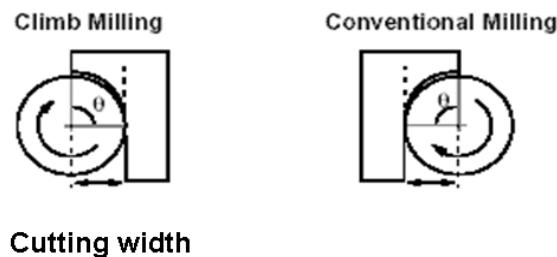

Figure 2.7-2 Climb/Conventional Cutting Figure

- **Cutting Coolant** : To decide whether or not to use the cutting function (M8).
- **Fine-Cutting Feed**: To decide the Tool Approach type when doing [Fine-Cutting]. Two types of fine-cutting feed which are vertical feed and arch feed. The preserve length before vertical feed is the radius of the tool. The arch radius is the radius for the tool feed.

2.7.4 Screen Operation Description

This system's operation is divided into 4 types which are described as below:

■ PRJMNG

This function page provides adding/deleting/modifying/checking for profile and island. When users want to add one profile or island, pressing adding button and then choosing profile or island to enter into the profile configuration definition page. If want to delete or modify the configuration, simply use the up/down of the direction key. The chosen configuration will be indicated in red color. Please refer below as the related screen:

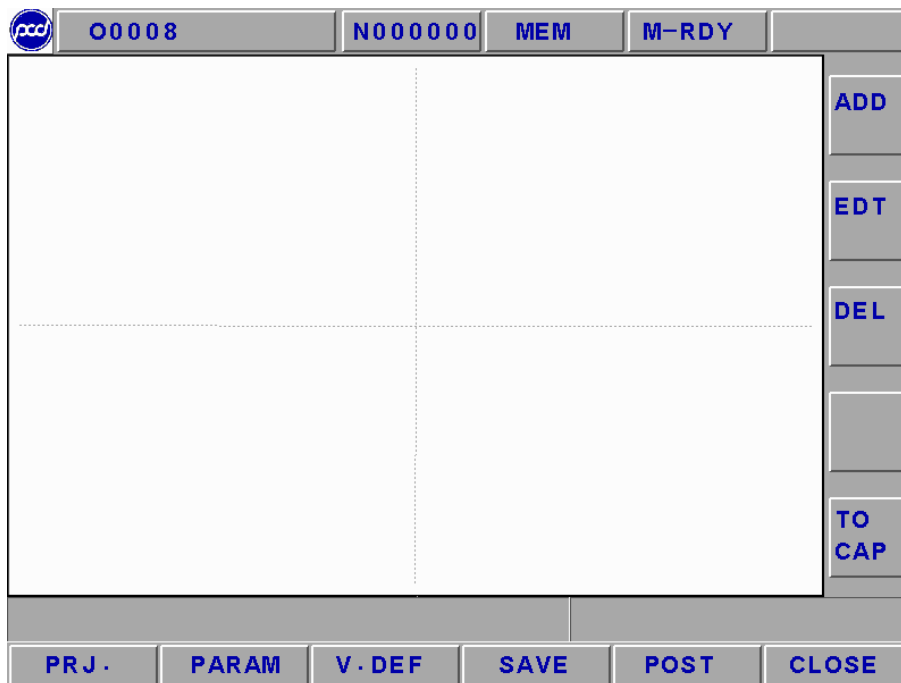

Figure 2.7-3 Main Function Page

The above figure is an example that shows 4 islands in one profile (DEMOI). Able to choose rough-milling and/or fine-milling in order to produce the related tool path O9999 after pressing NC gear shifting button.

■ V. DEF

When users select a profile or island at the main function page, must use this page to set the definition of this closed profile. Users must press the button at the right column of the screen when doing the picture. One of Line, ARC CW, ARC CCW, END and DEL will decide the type of the pixel. Since the definition of the profile must be closed, so must enter the definition of the profile in order to connect from head to end. Moreover, using the delete key from backward to forward.

Note : For geometric pixel entering, Pou Yuen Technology recommends users to label the key position of each figure elements on the working figure first in order to be more time-efficiency for entering time.

■ **CUT PAR**

This page is mainly to define the related CAM calculation and the output parameters. For each column's definition, please refer to the description of the related cutting parameters. All parameter definitions must be reasonable before pressing [NC Gear Shifting] button in order to produce the correct path program.

O5678		N000000		JOG	M-RDY
STR.Z	0.000	OFF.L	1		
END.Z	-2.000	H CODE	1		
DEP.H	2.000	RPM.S	1500		
CUT.W	5.000	XY.F	1800		
FIN.W	0.000	Z.F	1200		
ENTRY	2.000	TYPE	0		
TRAVER	4.000	M08	0		
DIA.T	8.000	APPRO	0		
NO.T	1	APP.L	0.000		
START PLANE.Z					
					RETURN

Figure 2.7-4 CUT PAR Page

Like the above Figure, it describes that this time's production is to cut from Z=0 to Z=-2 from the working face. Also, everytime's cutting depth is 2mm, the tool diameter is $\varphi 8$, the cutting width is 4mm, the fine-cutting preservation width is 2mm and etc.

■ **FILE MNG**

This page provides the following functions such as new project file building, deleting, opening old files and entering AutoCAD DXF files. Users must build a new file or open an old one before doing this job, otherwise, the related operation will not be able to do its job. Please refer below as the related screen:

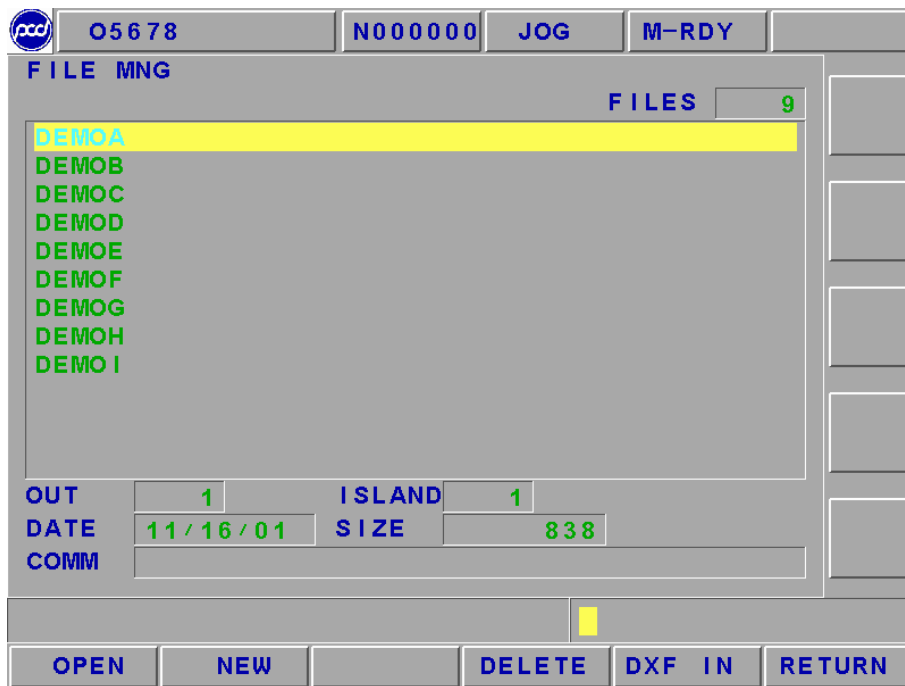

Figure 2.7-5 FILE MNG Page

Pressing the UP/DOWN direction key to select the wanted file. The Left/Right direction key can move the cursor to the [File Description] row and key-in the description for that file. Users are able to import the DXF file into the new project file or the present project file. Enter the new project file name into the entry row in order to import the new project file. On the other hand, if not entering a new project name, then the file will be imported into the present project file.

The following principles must be matched when AutoCAD is producing Figures: AutoCADFigure shape must be AutoCAD R14 DXF (*.dxf) when choosing to import.

1. Figure shape entity must be LWPOLYLINE, even using plane command to draw Figure.
2. Using color to differentiate profile or island. When definition is at machine\mmibase.ini , default value is: DxfOutloopColor=5 (Bleu, Profile) , DxfIslandColor =3 (Green, Island) .
3. No restrictions for the numbers of profile and island since they can be deleted after importing.
4. Figure shape is okay to be non-close since it can be modified after importing.

2.8 MILLING FIGURE CONVERSATION

2.8.1 PREFACE

This function provides a G code structure that is easier to use. There are four working methods: drill-machining, facing, side-cutting and pocketing. So users do not need to remember complicate G code types and parameter definitions. Users only need to follow the instruction of Figure Pane to key-in the related information. And then pressing gear shifting button in order to produce the needed part program.

2.8.2 Function Specification

In order to have more elasticity for this function, so Pou Yuen has designed projects and production management structure. Also, the followings are some restrictions due to the concern of the actual use:

- Project name is D0000~D9999, totally 10000 units.
- Every project allows having more than one production procedure. 99 production procedures are the maximum.
- Every project has one set of common parameters. Every production procedure has one set of cutting parameter.

2.8.3 Work Production Selection

This function provides 4 types, totally 15 working methods. Also, there are total 47 combinations due to each type has different working styles. The working function structure chart is as following:

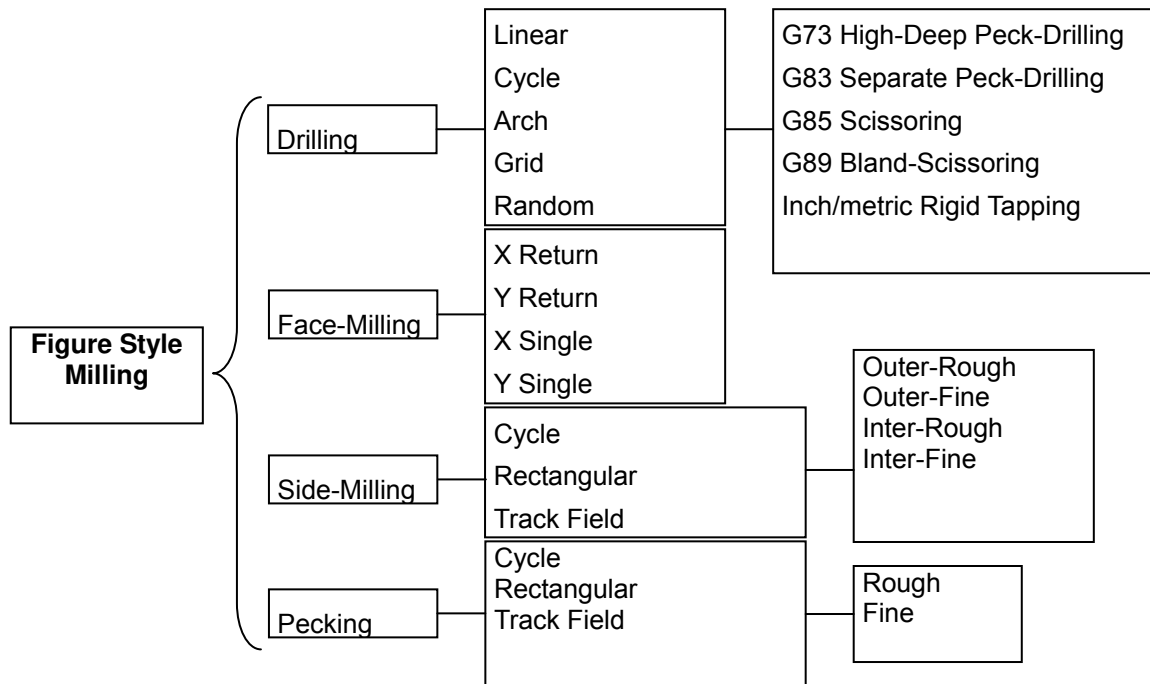

Figure 2.8-1 Working Function Structure Chart

1st Type: Drill-Machining, There are 5 working styles, which are G73, G83, G85, G89 and TAP. 5 working methods are as following:

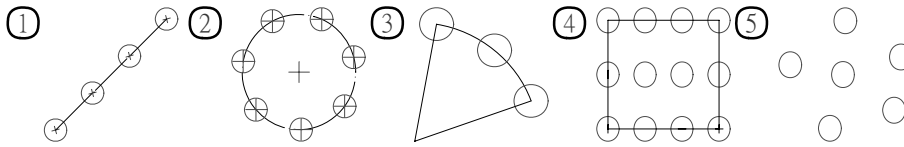

Figure 2.8-2 Drill-Machining

1. Linear type orientation (G101) ,
2. Circle type orientation (G102) ,
3. Arch type orientation (G103) ,
4. Square type orientation (G104) ,
5. Random type orientation (G105) .

2nd Type: Facing-milling, 4 working methods are as following:

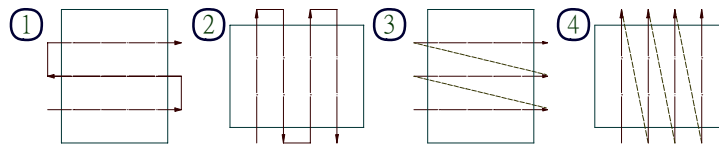

Figure 2.8-3 Face-Milling

1. X-axis two directions surface (G111) ,
2. Y-axis two directions surface (G112) ,
3. X-axis single direction surface (G113) ,
4. Y-axis single direction surface (G114)

3rd Type: Side-Milling, there are 4 types of this working methods which are external rough-cutting, external fine-cutting, internal rough-cutting, and internal fine-cutting. 3 working methods are as below:

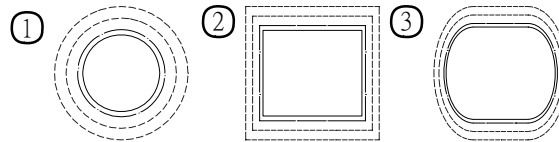

Figure 2.8-4 Side-Cutting

1. Circular side-cutting (G121) ,
2. Square shape side-cutting (G122) ,
3. Tracking field side cutting (G123)

4th Type : Pocketing, there are two working styles of this working methods which are rough-cutting and fine-cutting. 3 working methods are as below:

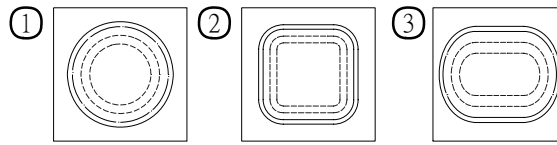

Figure 2.8-5 Pocketing

1. Circular pecking (G131) ,
2. Square pecking (G132) ,
3. Run-way pecking (G133)

2.8.4 Common Parameters Setting

System parameters are arguments of G100 which are used in all production procedures in projects. The description is as following:

- **Fixed Cutting Width:** whether or not the cutting width is fixed while tool feeding: Yes: 1; No: 0.
- **Tool Diameter:** tool diameter (mm) . This value should be a default setting value. The cutting parameter does not set the tool diameter so using this value as the standard.
- **Escape Value:** Z direction escape height (mm) .
- **Feed Speed:** feed speed (mm/min) . This value should be a default setting value. If cutting parameter does not set feed speed, use this value as the standard.
- **Feed Ratio:** setting the percentage ratio (%) of tool feed to tool diameter every times.
- **Spindle Rotational Speed:** spindle rotational speed (rpm). This value should be a default setting value. If the cutting parameter does not set the spindle rotational speed, using this value as the standard.

2.8.5 Cutting Parameter Setting

The needed setting parameters and definitions are different due to different working methods. Please refer to the description of arguments of the corresponding G code in the program manual.

2.8.6 Operation Screen Description

This system's operation is divided into 4 types and they are described as below:

■ **PMNG**

This function page mainly provides add/delete/modify/check for production and procedure and save/gear-shifting and exit for projects. Every production procedure must edit 4 items. Tool number and compensation can be inputted directly. G code and cutting parameter can continue editing after clicking the input key. Since CAD/CAM and figure transmitting are in the same function group, so screen is able to switch to CAD/CAM editing page by pressing CAM button. Please refer below as the related screen.

Users can use the direction key up/down to move the yellow cursor and also to decide the wanted editing production procedures or items. The delete key (del) can delete the production procedure at the row where the yellow cursor occurs.

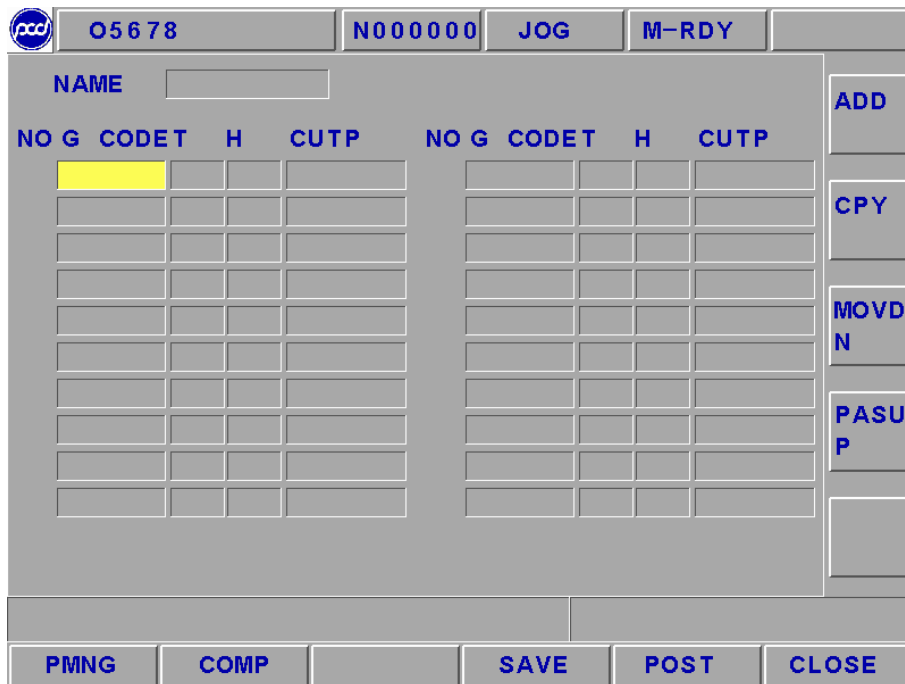

Figure 2.8-6 PMNG Page

■ **PMNG**

This function page mainly provides open, copy, rename, delete and note for projects. All operating methods are to key-in data before clicking on function keys expect opening files. If key-in a new file name, then a new file will be opened. Otherwise, the system will open the file that is in the file list where the yellow cursor occurs. Return button is to switch back to the figure transmitting main function page. **Note:** please open the file at that page before start editing at the main function page. Please refer below for the related screen.

Users not only can use the up/down key to move the yellow cursor but also use the pgup/pgdn key to do extensively moving. The notice display of the file is within the bracket of the file list.

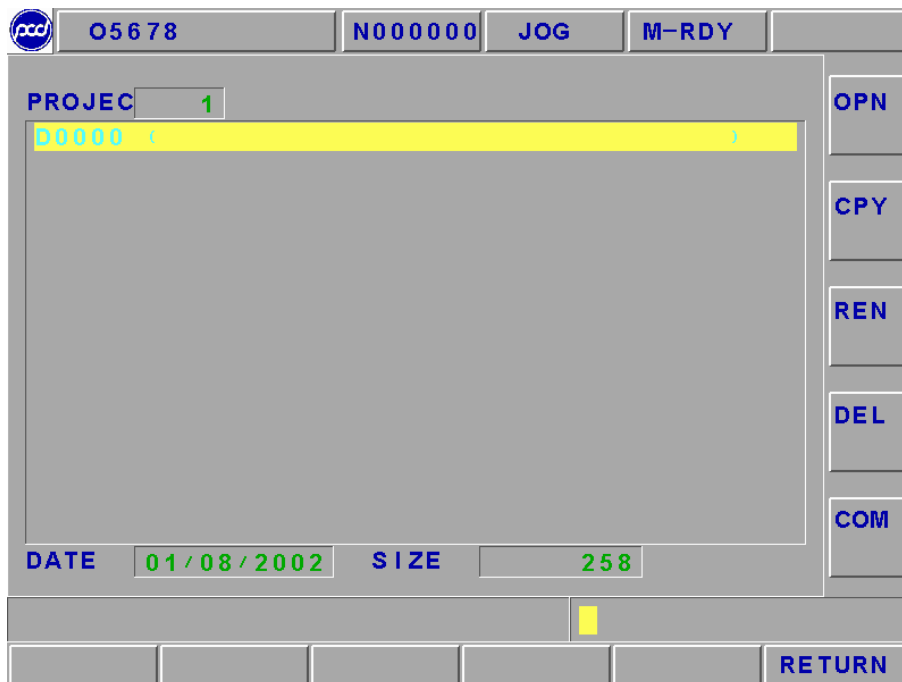

Figure 2.8-7 PMNG Page

■ **COMP**

This page's main function is to set the local parameters of all project production procedures. Pressing return button will be able to switch back to the main function page of the figure transmitting after complete setting. Please refer below as the related screen:

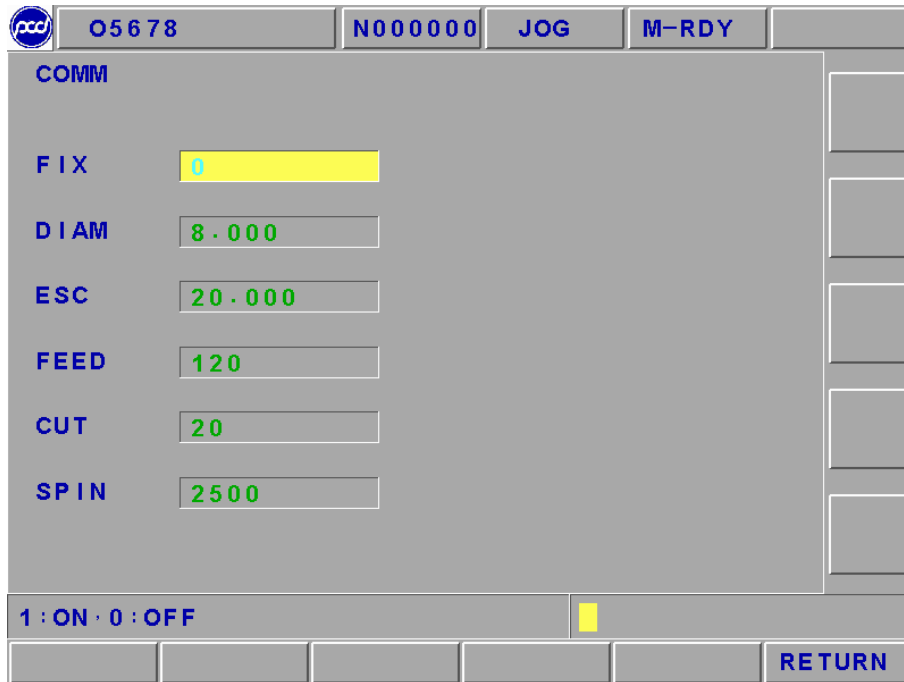

Figure 2.8-8 COMP Page

■ **G Code Selection Page**

This page's main function is to select working method. Pressing the return button to switch to the figure transmitting main function page after selecting.

Please refer below as the related screen.

Using the direction keys up/down/left/right to move the yellow square before pressing the function button at the right side in order to complete the selecting motion. The figure at the right side and the function buttons will be different according to the item in the yellow square at the left side.

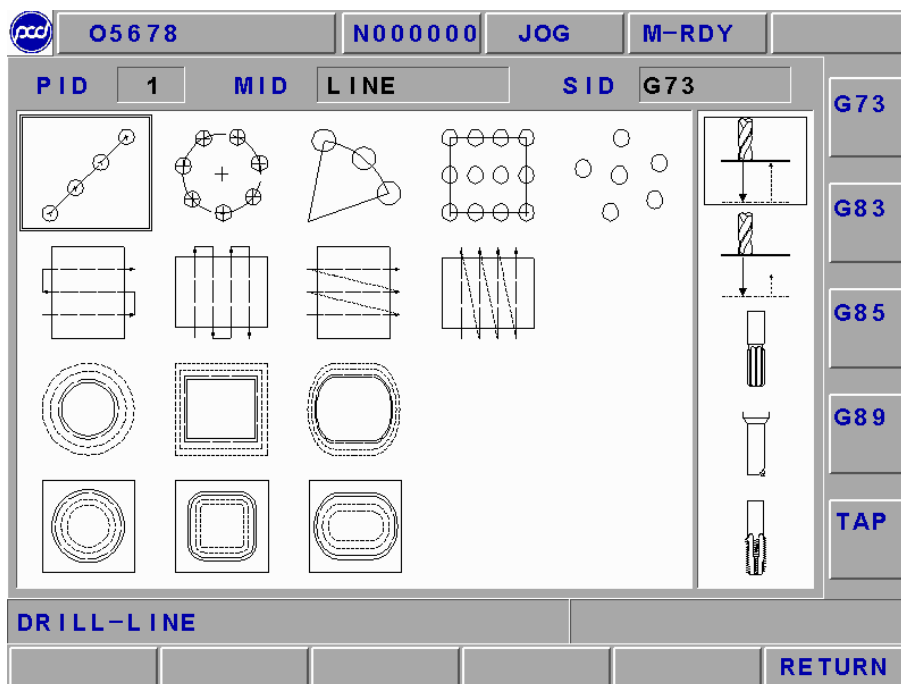

Figure 2.8-9 G Code Selection Page

■ **CUT PARAM**

This page is mainly to set the cutting parameter of a single production procedure in a project. Pressing the return button to switch back to the figure transmitting main function page after complete setting. Please refer below as the related screen:

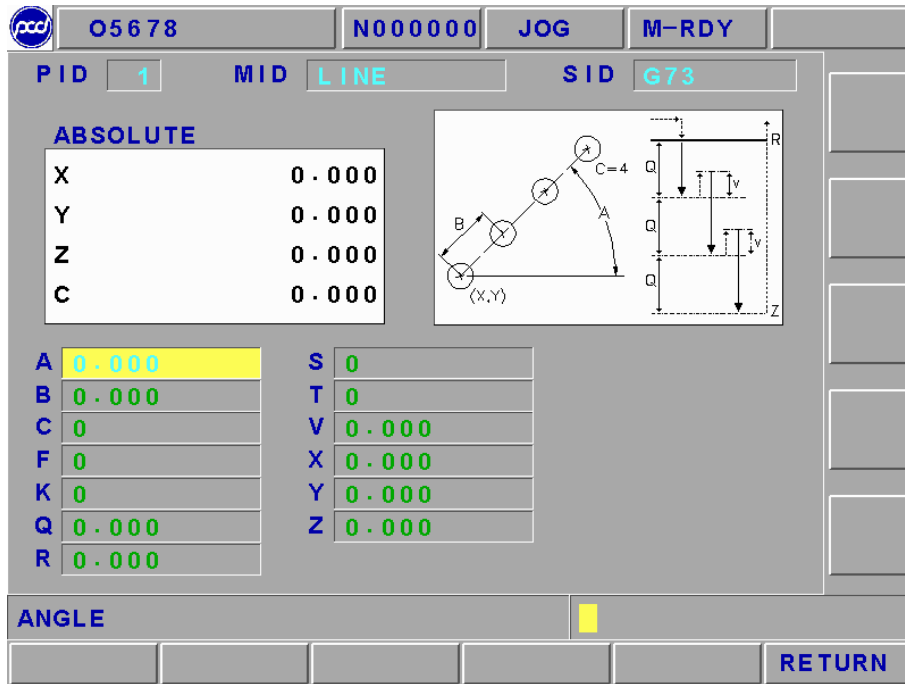

Figure 2.8-10 CUT PARAM Page

Users only need to use the figure shape reminding at the upper right side and then to key-in the related information in order complete setting. When the setting column is the diameter (Parameter # T), a function key as “T Set” will occur. The function button is to key-in the 2 times of the radius compensation value of the corresponding tool number at the OFFSET page into this column according to the setting tool number at the main function page.

2.9 GRAPH

2.9.1 Function Introduction

Pressing **【GRAPH】** to enter into this function group. The present working path and that of the preview programs will occur in **【GRAPH】** screen. Users are able to set the view angle and the display range of the path display in **【SET】** screen.

2.9.2 GRAPH

The path display screen is as the below Figure. Coordinate value that is displayed at the upper-right side is the absolute coordinate of the present tool position. Lower-right side displays the coordinate view angle

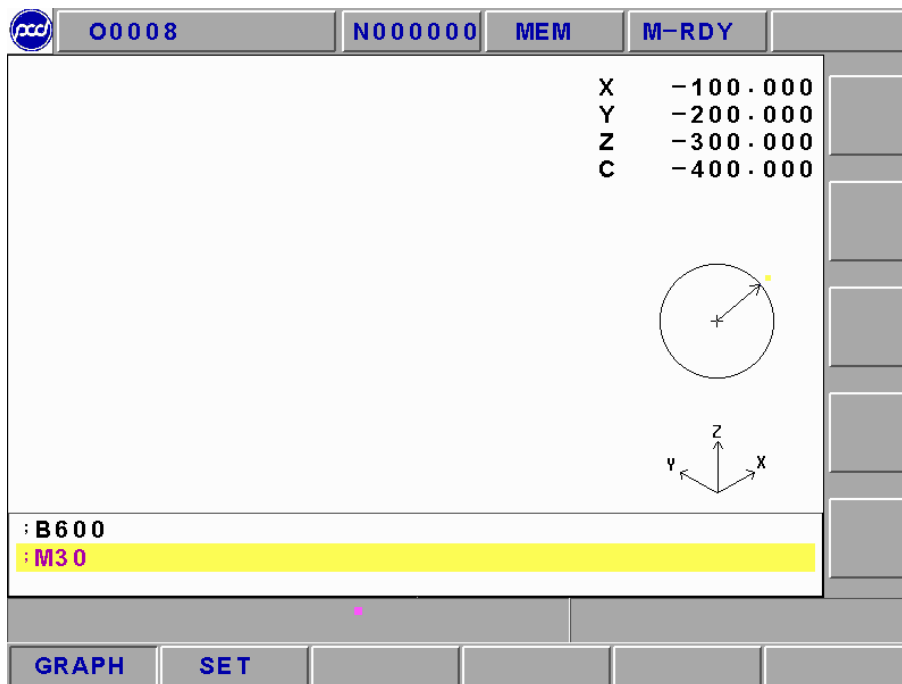

Figure 2.9-1 GRAPH Screen

Note 1: Cursor is green color, G00 is red color and G01, G02 and G03 are yellow color.

Note 2: Cursor is green color, G00 is blue color, and G01, G02, and G03 are pink color.

Center line is bright-green color.

2.9.3 SET

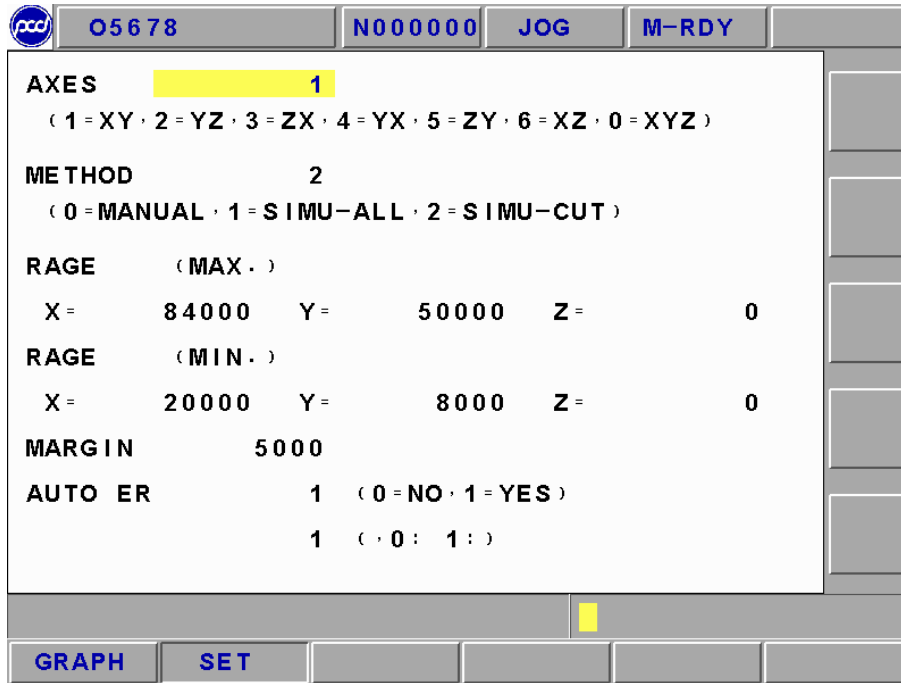

Figure 2.9-2 Main Screen of the Windows Definition

- **Drawing Surface:** the using coordinate view angles are (1=XY, 2=YZ, 3=ZX, 4=YZ, 5=ZY, 6=XZ, 0=XYZ) when key-in into the path display screen.
- **Setting Method :** the drawing range of the entering **【SET】** screen (0>manual, 1= preview result-full travel, 2= preview result-cutting travel).
 - **0 manual :** preview the drawing range as the reading manual setting's max/min values.
 - **1 preview result→ full traveling (including moving path) :** preview the drawing range as the reading part program path's max/min values, the smallest value.
 - **2 preview result→cutting traveling (only including cutting path) :** preview the drawing range as the max and/or min values of the reading cutting path, the smallest value.

- **Drawing Range (max)** : setting to use the manual method to draw the largest value of X, Y, and Z axes range.
- **Drawing Range (min)** : setting to use the manual method to draw the smallest value of X, Y, and Z axes range.
- **Preserve Border** : setting the preservation value for **【SET】** screen border.
- **Auto Delete** : assumed under the condition of not executing program preview. Users are able to choose whether or not to delete the previous path display screen when enable cutting function while the machine is doing the path display (0= Not Delete , 1=Auto Delete) .

2.10 DGNOS

Pressing <DGNOS> and 6 main function screens occur, which are **【ALARM】**, **【SYSUPD】**, **【IOCSA】**, **【MLC2】**, **【SYSTEM】** and **【CIRCUL】**. Users are able to know the condition of HMI signal and machine condition from the DGNOS function screen in order to do the maintenance and the system testing.

2.10.1 ALARM

Clicking **【ALARM】** to enter into the **【ALARM】**, **【WARN】**, **【HISMSG】** and **【LOGHST】**. When there is any alarm message or warning message from MLC, the alarm message will occur on the screen. Users can use this screen to remove any irregular condition of the controller.

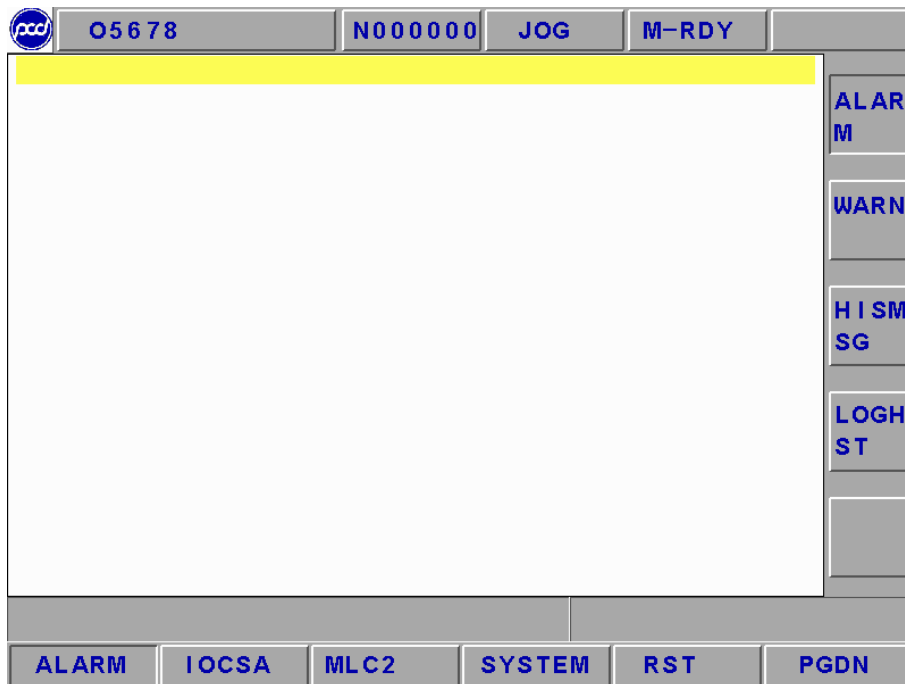

Figure 2.10-1 ALARM Message Screen

【ALARM】

Alarm message will occur when there is any problem in system running. This will make the system stop running and also will display the alarm message on the screen. When the problem is solved, must press <RESET> in order to release the situation.

【WARM】

Warning message is decided by matching with the design of the MLC LADDER. Example is when the safety door is not closed completely, LADDER program will send out “DOOR NOT CLOSE” message. Or, when the Coolant Supply is broken, then the message “COOLANT LAW” message will be sent out.

So when the alarm message occurs, please check the conditions of machine and peripheral equipments according to the LADDER program. The system will stop running when the system sends out the warning message and the warning message will be displayed on the screen. When the problem is solved, must press <RESET> to release the warning.

【HISMSG】

System version and program debugging message will occur. This page displays the system current running condition.

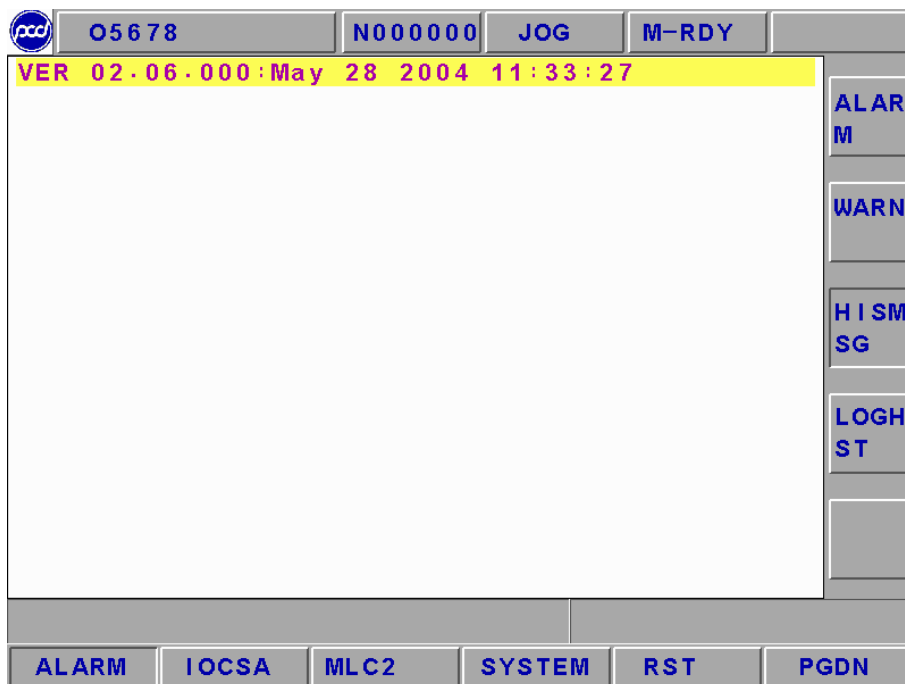

Figure 2.10-2 Message Page

【LOGHST】

Able to display the version and program debug message after entering into the message screen. Message displaying will not disconnect the working procedure, but it displays the present running condition of the system.

2.10.2 IOCSA

【IOCSA】 is to check the screen of the I/O or system internal condition which including I, O, C, S, A.

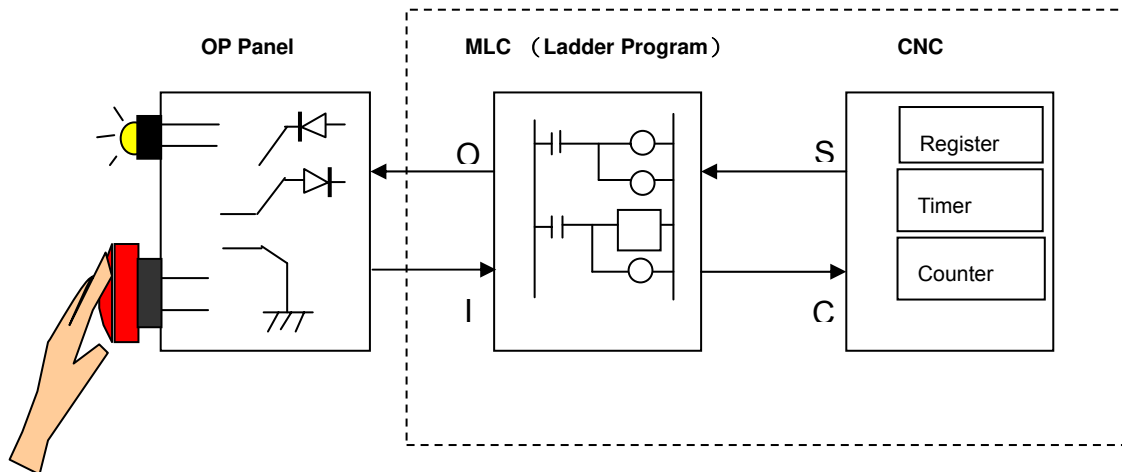

Figure 2.10-3 I/O or Internal Condition

O5678		N000000		JOG		M-RDY		
I	000	0	0	0	0	0	0	I BIT
	010	0	0	0	0	0	0	
	020	0	0	0	0	0	0	
	030	1	0	1	0	0	0	
	040	1	1	1	1	0	0	
	050	0	0	0	0	0	0	
	060	0	0	0	0	0	0	
	070	0	0	0	0	0	1	
O	000	0	0	0	1	0	0	O BIT
	010	0	0	0	0	0	0	
	020	0	0	0	0	0	0	
	030	0	1	0	0	0	0	
	040	1	0	0	1	0	0	
	050	0	0	1	0	0	0	
	060	0	0	0	0	0	0	
	070	0	0	0	0	0	0	
C	000	0	0	0	0	0	0	C BIT
	010	0	0	0	0	0	0	
	020	0	0	0	0	0	0	
	040	0	0	0	0	0	0	
S	000	0	0	0	0	1	0	S BIT
	010	1	0	0	0	0	0	
	020	0	0	0	0	0	0	
	030	1	0	0	1	0	0	
A	000	1	0	0	0	1	0	A BIT
	010	0	0	0	0	0	0	
	020	0	0	0	0	0	0	
	040	1	1	0	0	0	0	

Figure 2.10-4 IOCSA Main Screen

This screen is divided into 5 parts. The assigned method of the focus point is to assign via sub-function button. The assigned type is displayed on the upper left column of the screen (Using the above Figure as an example. Pressing the sub-function button **【I BIT】**, the type will be displayed at the upper left column of the screen.); < PAGE ↑ > and < PAGE ↓ > keys are used to control the page changing of this **【I BIT】** sub-function.

2.10.3 MLC2

Pressing **【MLC2】** and the main function key screen is as below. Users will see **【LAD】**, **【CNT】**, **【REG】**, **【DRG】**, and **【TMR】** functions.

Pressing **【LAD】** and the screen is as below:

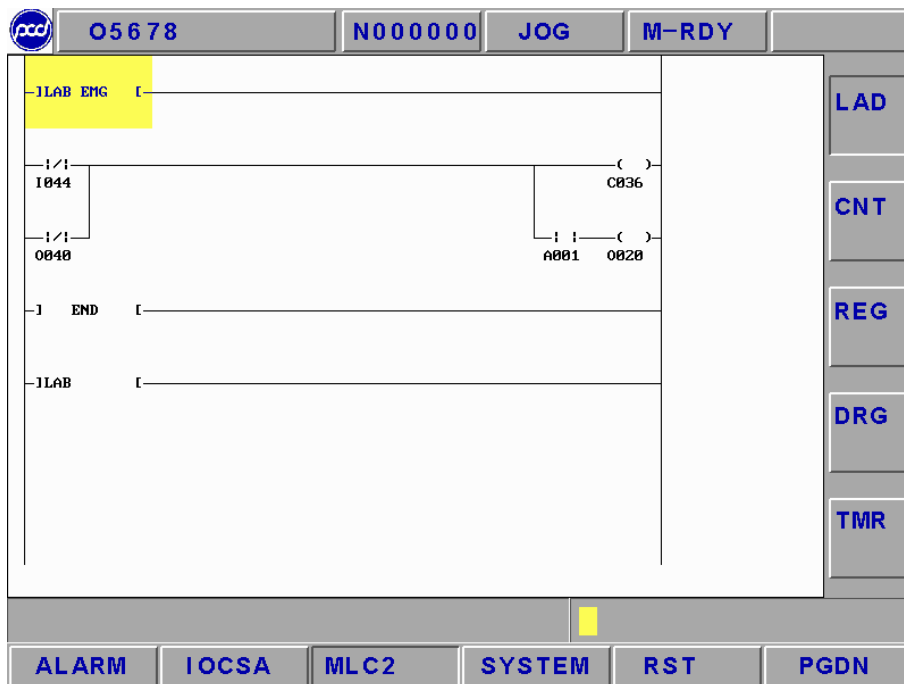

Figure 2.10-5 LADDER Figure

Users are able to add number on the wanted searching English characters, such as I, O, C, S, A, R, TM and est. in **【LAD】** entering row. Pressing **【INPUT】** to start searching the position of those characters. For example: key-in TM001 or TM1 to search for the position.

2.10.4 SYSTEM

Pressing **【GBL】** and the screen is as below. (System data is to display screen of the system maintenance variable. This function is for designers and technical people to use.)

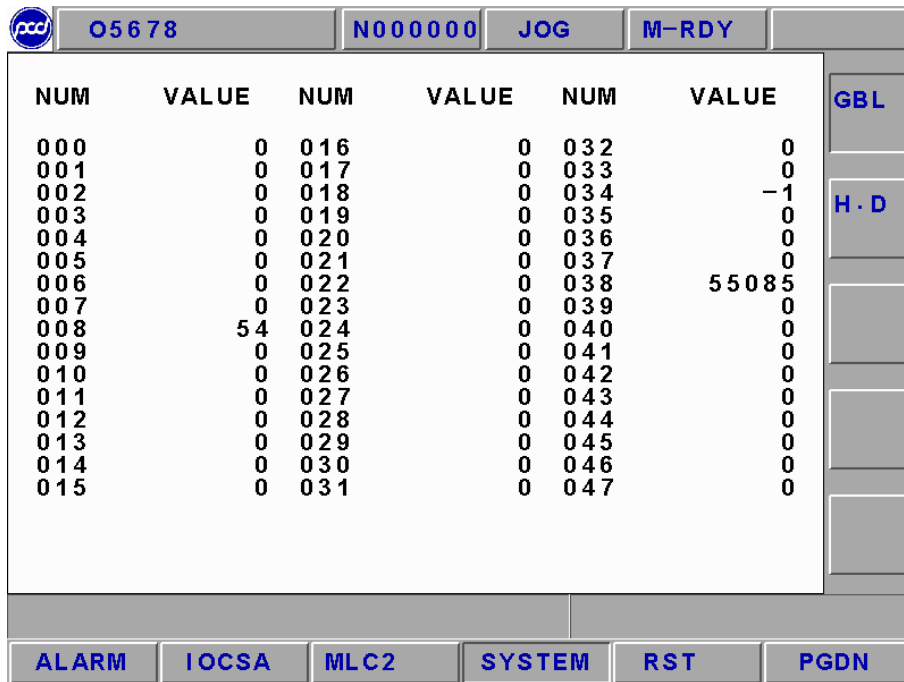

Figure 2.10-6 System DataSystem

#	Definition	#	Definition
0	X-axis servo lag counting value	16	X-axis hand wheel command counting value
1	Y-axis servo lag counting value	17	Y-axis hand wheel command counting value
2	Z-axis servo lag counting value	18	Z-axis hand wheel command counting value
3	4th-axis servo lag counting value	19	C-axis hand wheel command counting value
4	Waiting MST to ready signal	20	BLOCK times
5	In Position Checking	32	Actual X-axis machine

			coordinate value
6	Actual spindle rotational speed	33	Actual Y-axis machine coordinate value
7	Spindle servo lag counting value	34	Actual Z-axis machine coordinate value
8	Spindle commanding value	35	Actual 4th-axis machine coordinate value
9	Angle of spindle orientation	36	Index ISR Counter
		38	ISR Counter
10	Spindle orientation arrival range PLUSE	39	Distance between present Spindle position to index

● 【H.D.】

There are 9 items in the diagnosis function item. These function items are to check whether or not the connection cable from motion card to I/O card is connected. Or, checking whether or not the Jump position is correct. If the question mark (?) changes to across (X) after diagnosis on the right windows side, it indicates this item has error. Users are able to get the possible error message from the solving method in order to check and to solve the problem.

The HOME DOG condition at the top of the windows indicates that if the value of each axis is 1, the present position of each axis is on the HOME DOG.

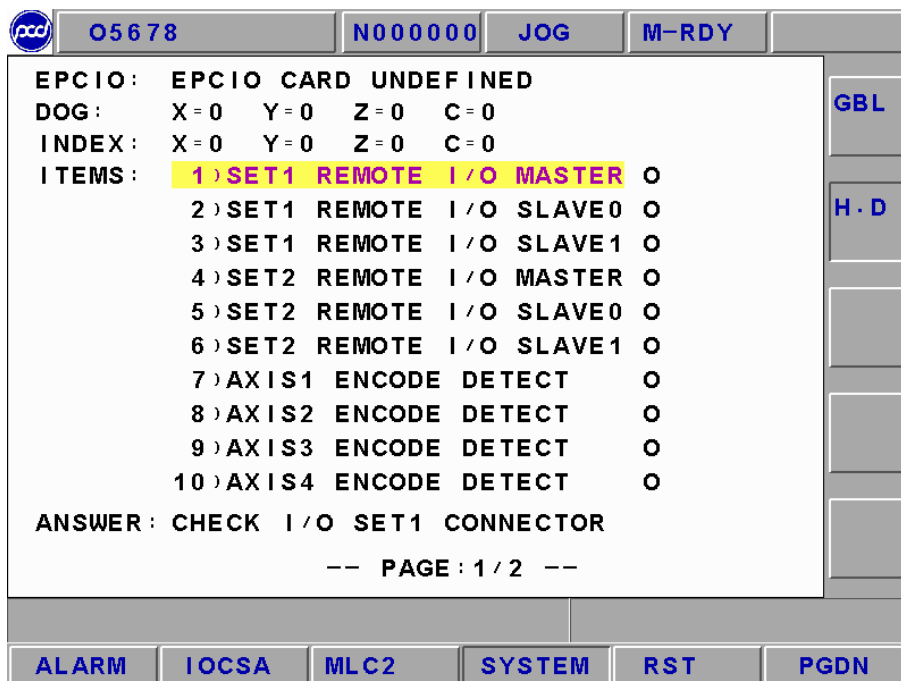

Figure 2.10-7 SYSTEM.H.D.

2.10.5 Working Parameter Page

Cutting Time : When users press “Cycle Start” button on OP, cutting time will reset to zero and then start timing until the part program finishes.

Working Time : Working time is the sum of cutting time everytime rebooting. It will be set to zero until exit (returns to zero). Using **【RST】** + **【RUNTIME】** will return the working time back to zero immediately.

Working Piece : When CNC has read M02, M03 or other M codes, the system will adding up the working piece automatically. Using **【RST】** + **【PARTCONT】** will return the working piece number back to zero.

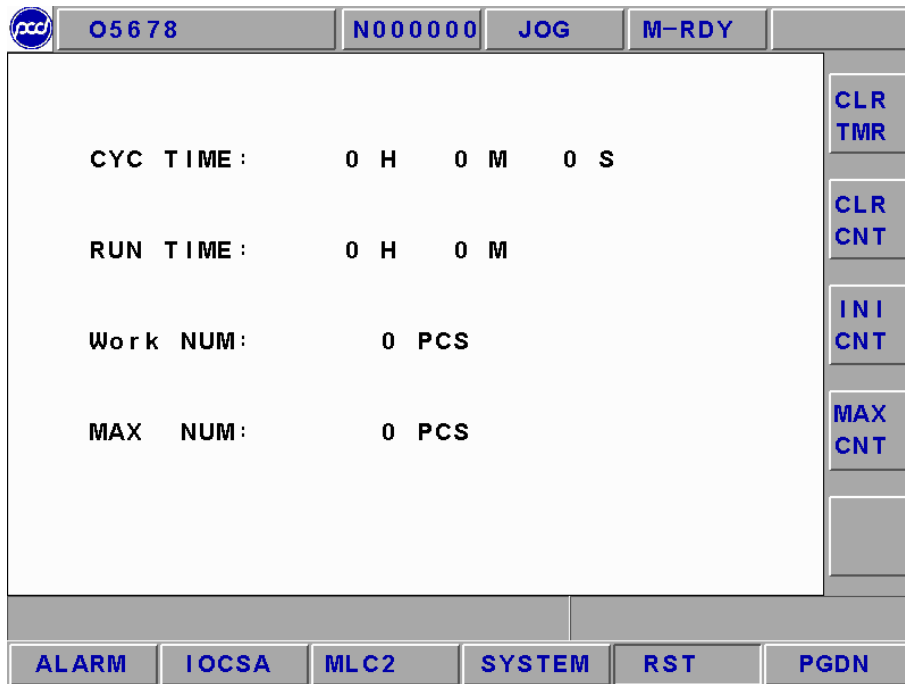

Figure 2.10-8 Working Parameter Page

2.10.6 SYSUPD

This function can be executed only under that condition that CNC is not ready. Please pressing **[SYSUPD]** button after pressing the EMG-STOP key. At this time, a screen which function is selected by the cursor (like Figure 2.10-3) will occur. This screen allows users to select the wanted working item. Each function is listed as below:

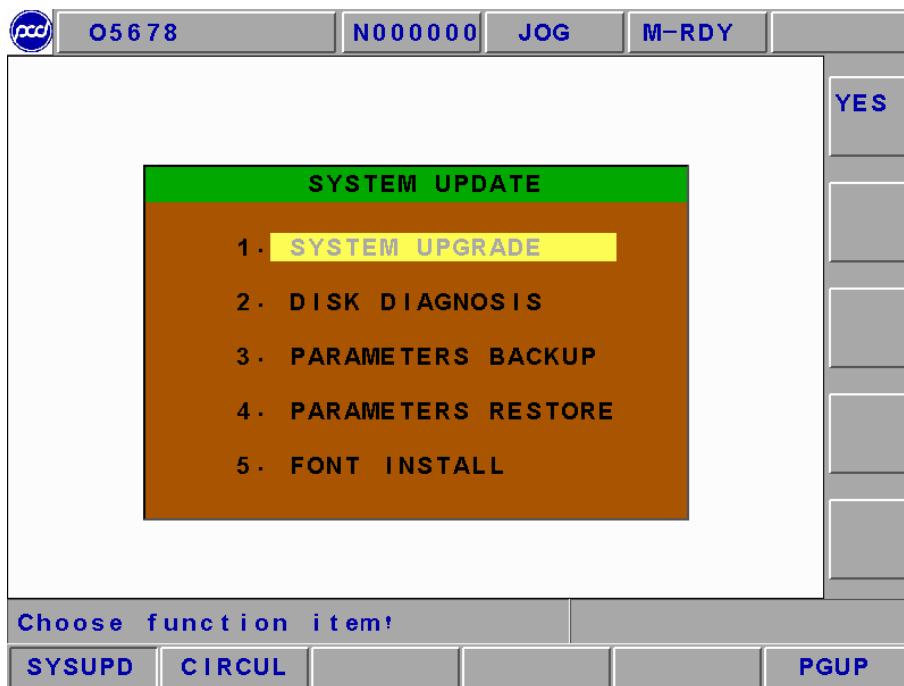

Figure 2.10-9 System Upgrade Screen

● SYSTEM UPGRADE

Please install Pou Yuen's newest version software if choosing this function. Pressing **【YES】**, the installation screen will occur. There is installation program instruction during installation so only need to follow the instruction to upgrade the system.

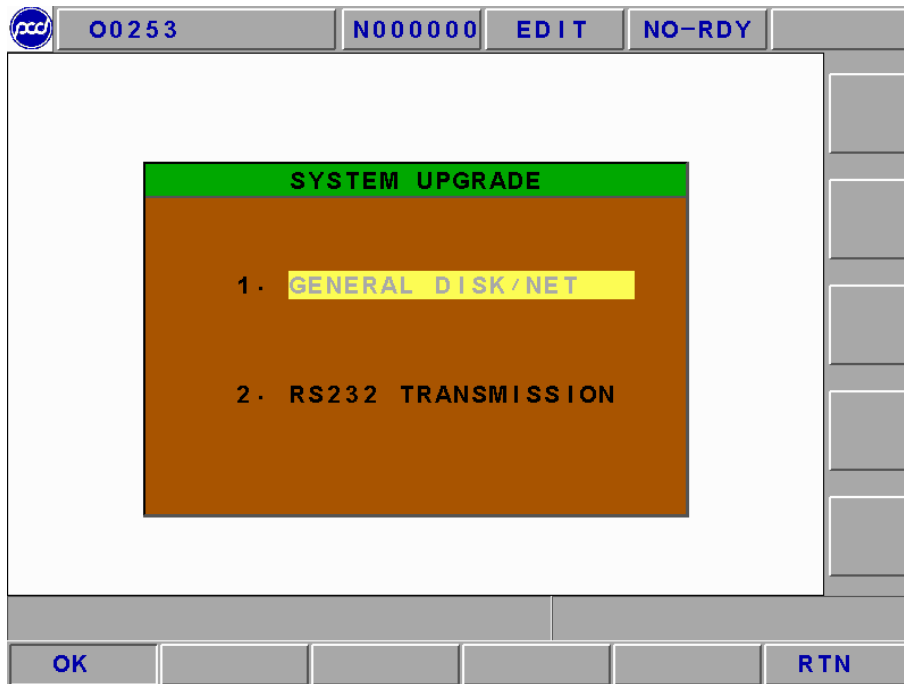

Figure 2.10-10 SYSTEM UPGRADE

● H.D CHECK (DISK DIAGNOSIS)

Selecting this function, a confirm dialog box will occur.

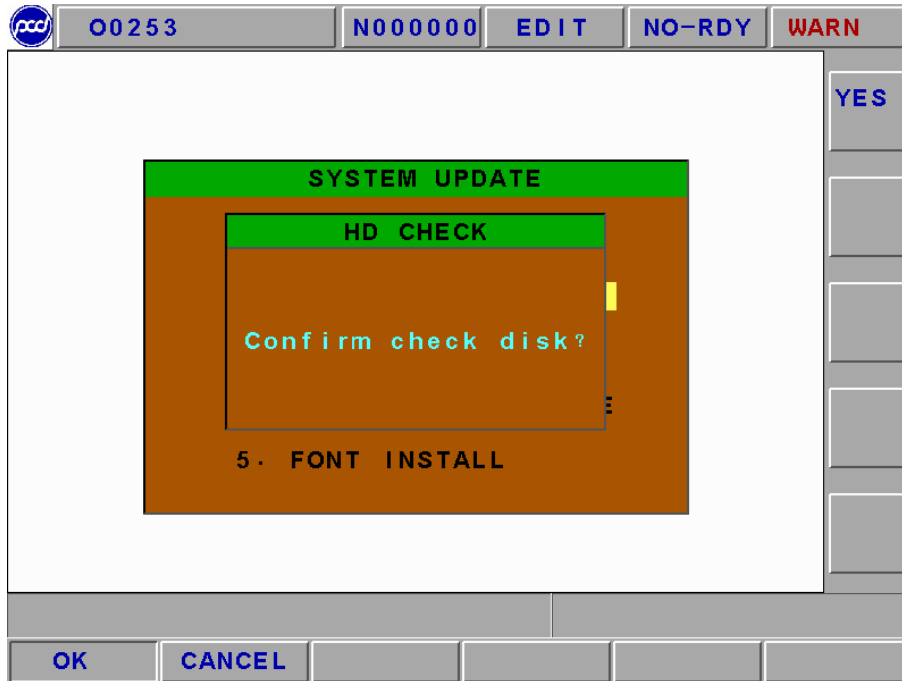

Figure 2.10-11 Confirm Whether or Not to Do the Hardware Checking

Pressing the confirm button to return back to DOS mode . Users are able to choose to use A drive or C drive. If users do not choose, the system will use the default C drive. There are 4 types of working items for users to choose:

- (1) .anti-virus (2) .hard drive scanning (3) .hard drive reset (4) .exit

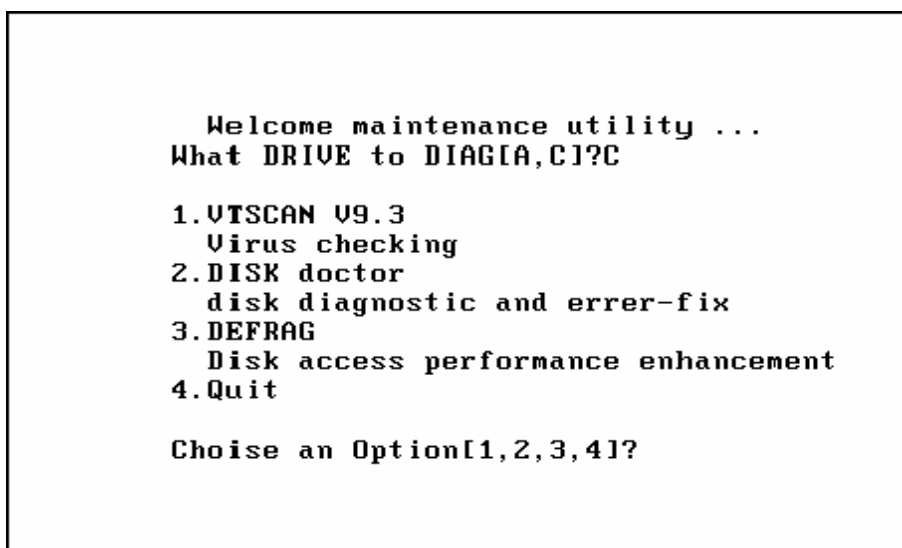

Figure 2.10-12 Hardware Checking Function Selection

● PARAM BACKUP

The below dialog box will occur when choosing this function. Users are able to choose the wanted backup parameter item. Users are able to key-in the dialog box of the backup copy path after pressing the confirm button. Pressing the confirm button after users key-in or select the wanted backup parameter to complete the parameter backup function.

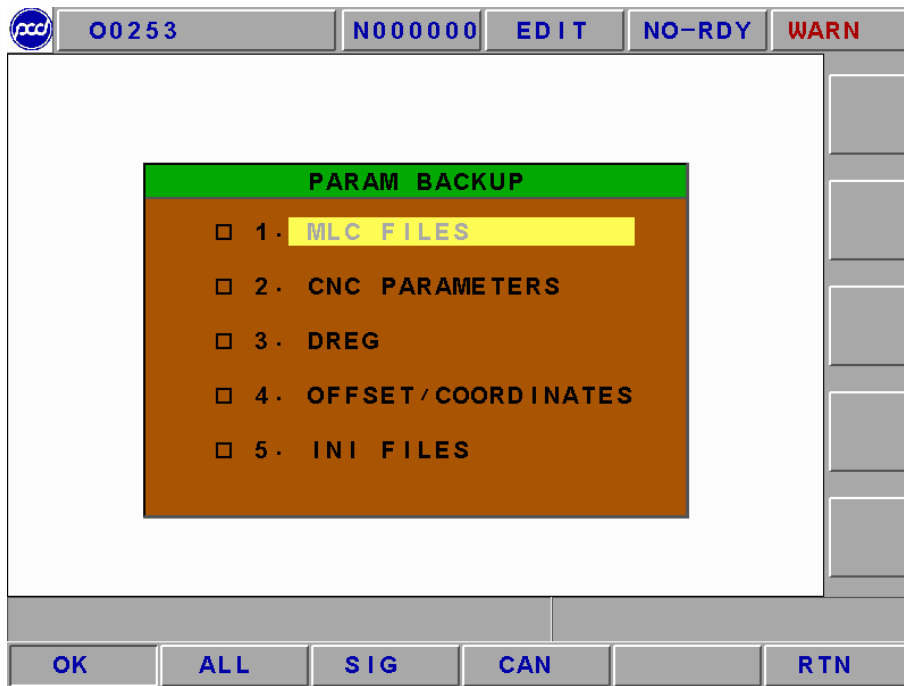

Figure 2.10-13 PARAM BACKUP Selection Screen

● **PARAM LEAD-IN**

By choosing this function, a window dialog box will occur to remind users that needs to reboot program



Figure 2.10-14 Reminding Users to Reboot after Key-in Parameter

If executing this function. Selecting the “renew parameter” item from the popup dialog box after pressing confirm button. A dialog box of key-in parameter renew source path occurs after pressing confirm button.

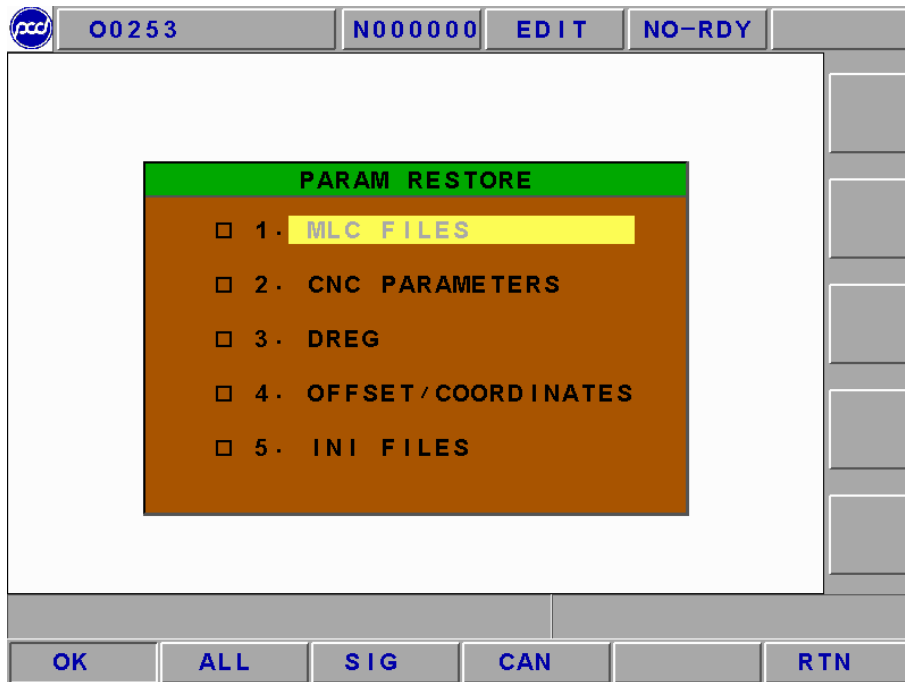

Figure 2.10-15 Screen of Choosing Key-in Parameter

Key-in or select the source path and file name after pressing confirm button to key-in parameter file.

● Text Font Installation

After user selects a designated text font source, please pressing **【OK】** .

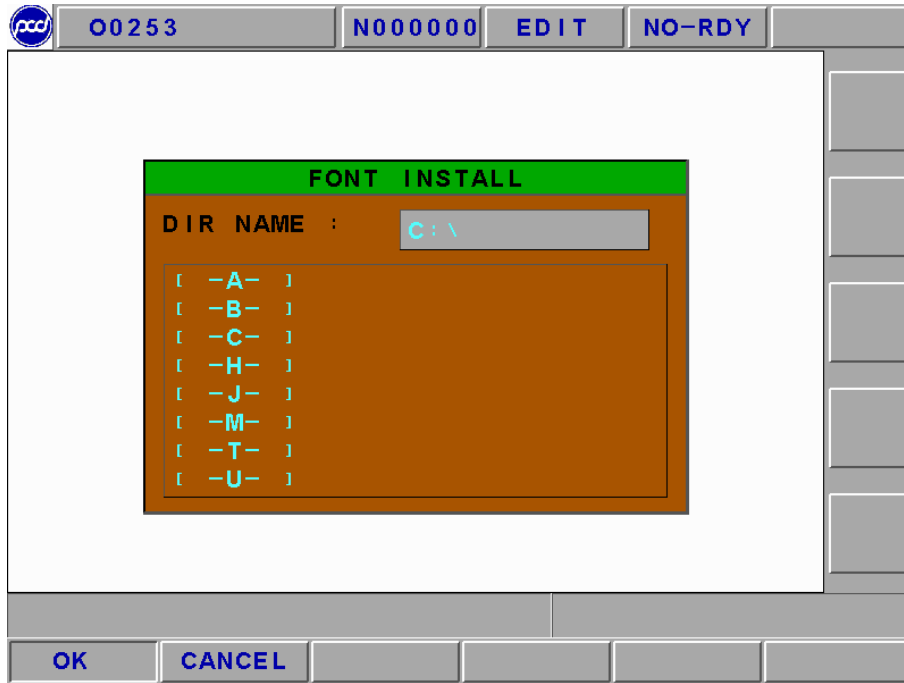

Figure 2.10-16 Text Font Installation Source Page

2.10.7 CIRCUL

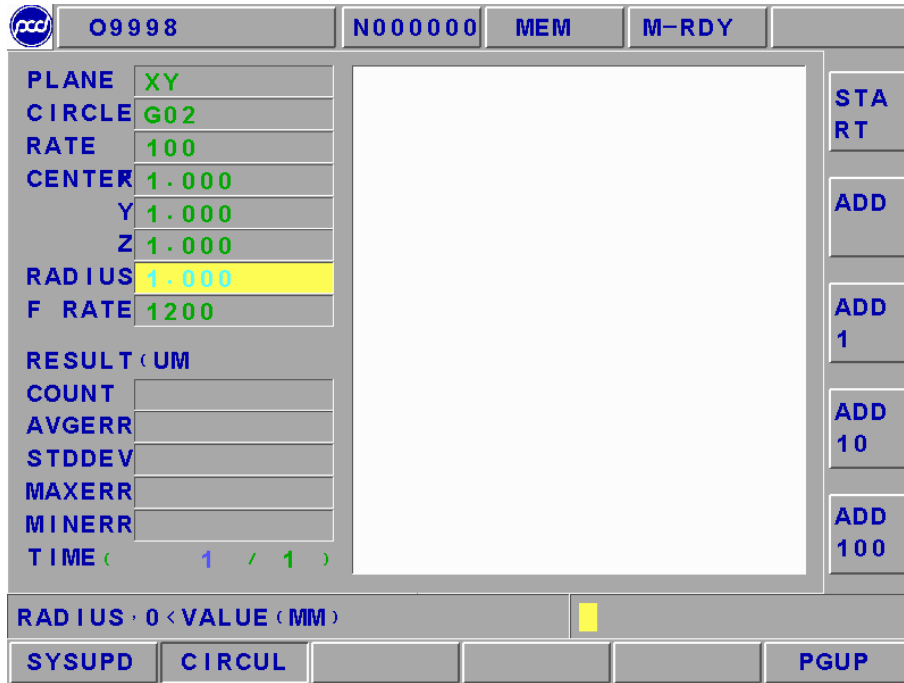

Figure 2.10-17 CIRCUL Screen

- 【Panel】** Able to choose any one of XY, YZ, ZX panes as the circular pane from the popup menu after pressing <input>.
- 【CW/CCW】** Able to choose CW (G02) or CCW (G03) as the cycling motion from the popup menu after pressing <input>.
- 【Sample Period】** Setting the sample interval time (ms) for estimation error.
- 【Center Point XYZ】** Absolute coordinates (X 、 Y 、 Z) of the entered center point.
- 【Radius】** Setting radius of circular (mm) .
- 【Feedrate】** Setting feedrate of circular (mm/min) .
- 【Sample Point #s】** Total numbers of the sample estimation: Sample point numbers=

$$(2 \cdot \text{PI} \cdot \text{circular radius} \cdot 60 \cdot 1000) \div (\text{feedrate} \cdot \text{sample interval}) .$$
Note : PI= 3.1415926
- 【Average Error】** Display average error value.
Average error =total/sample point numbers
- 【Standard Error】** The difference between the data information and the balance number.

- 【Max Error】** The largest circular error value.
- 【Min Error】** The smallest circular error value.
- 【Ratio】** Display the circular error's zoom-in ratio $(N / 1)$, N is the ratio.
Note: the canned cycle error is the distance between each simple point and the center point and also the different value between each simple point and cycle radius.
- 【Ratio +/-】** To set the error zoom-in ratio of the sub-function operation button. Pressing this key, this button will be sagged and **【Ratio -】** will occur. Pressing the key again, this button will be raising and **【Ratio +】** will occur.
- 【1】** When the upper key displays **【Ratio +】**, the ratio will increase by 1 when pressing this button.
When the upper button display **【Ratio -】**, the ratio will decrease by 1 when pressing this button.
- 【10】** when the upper button displays **【Ratio +】**, the ratio will increase by 10 when pressing this button.
When the upper button display **【Ratio -】**, the ratio will decrease by 10 when pressing this button.
- 【100】** when the upper button displays **【Ratio +】**, the ratio will increase by 100 when pressing this button.
When the upper button display **【Ratio -】**, the ratio will decrease by 100 when pressing this button.
- 【Starting】** After canned cycle parameter setting is completed, pressing this button in order to indicate the setting is completed. Wait until the users press CYCLE START button in order to start the canned cycle motion. Pressing this button again, the key will raise, which means the canned cycle motion is canceled.

2.11 SOFTPL

Press <SOFTPL> to enter into the diagrams display screen. There are 7 function selection switches which are corresponding to 8 function buttons on the screen and they are **【MST SKIP】**, **【MPG DRY】**, **【Z IGNORE】**, **【M LOCK】**, **【DRY RUN】**, **【OP SKIP】**, and **【OP STOP】**.

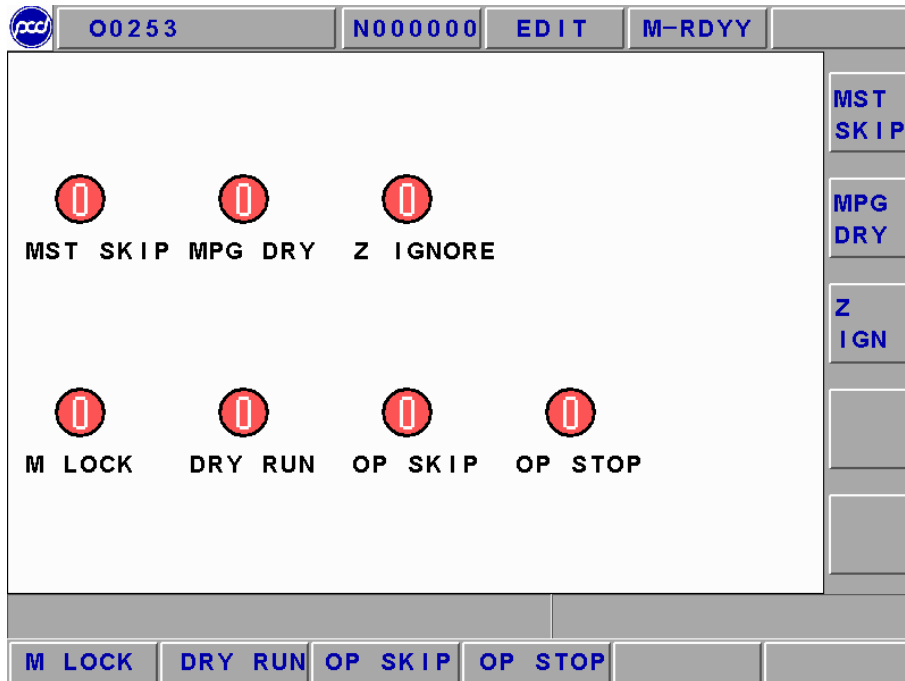

Figure 2.11-1 Soft Panel Function Screen

Using these corresponding function switches separately. The function picture changes from red to green on the screen, which means the function is enabled. Turning it back again to disable the function.

The Below Table Describes Each Soft Panel Function Selection Switches:

Function Switches	ON	OFF
Hand Wheel Dry Run	Hand wheel can modify the program coordinate, but the servo axis will not move actually.	Hand wheel can modify the program coordinate and let the servo axis moves according to it.
Auto-OFF	Automatic executing power disconnecting and exit motions after finish program executing.	Auto-OFF.
Optional Skip	Program begins with "/" symbol will be skipped and not be executed.	Single block that begins with "/" symbol will be executed normally.
Optional Stop	The program will stop when the program executes up to M01. If want to continue executing, users need to press "CYCLE START".	Controller will ignore M01 and execute the next single block directly.
Dry Run	While executing the program, the servo feed is according to the dry run speed parameter, not according to the assigned speed of the program.	The designated speed of the servo feed program.
MST Ignore	Ignore M, S, T codes commanding	Consider M, S, T codes commanding
Machine Lock	The controller will continue executing program while the program is executing. But, the moving command of the servo axis will NOT be outputted. So actually, the servo axis is	The moving command of the servo axis will be outputted with the program while the program is executing.



Function Switches	ON	OFF
	completed stop (no movement).	

2.12 PARAM

Pressing <PARAM> and the parameter setting screen occurs. There are three main function menus which are **【NC. SYS】**, **【USROPT】** or **【LNCS】**.

2.12.1 NC. SYS

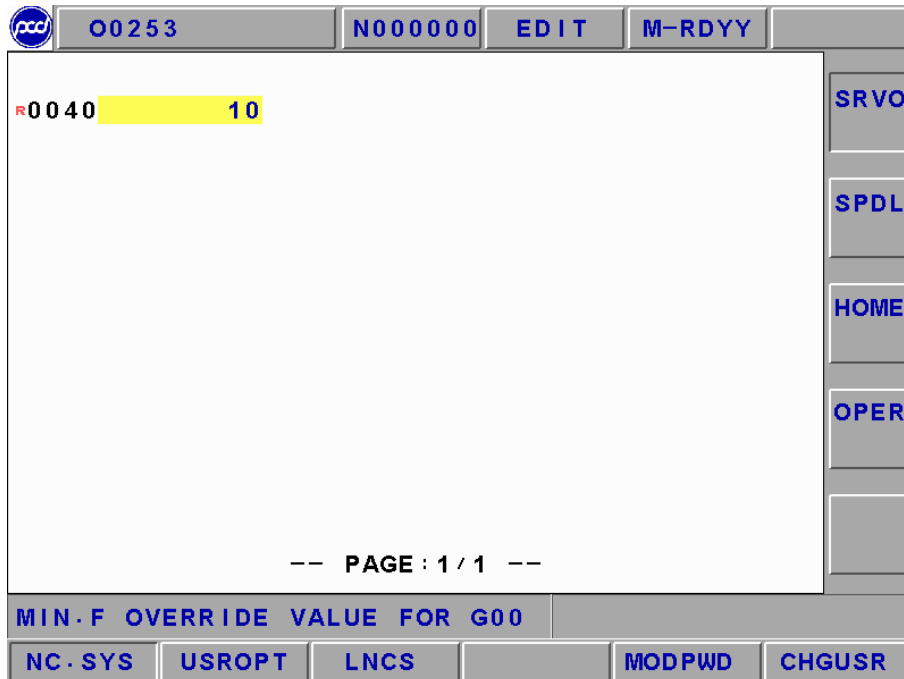

Moving the highlighter to the wanted modify parameter. The message hint section will have parameter description. Key-in the wanted modify parameter value into the column and then press <INPUT> to modify the parameter.

4 types of system parameter effective time.

1. ↶ (Effective after re-power) ;
2. R (Effective after RESET) ;
3. ⊙ (Effective after rebooting) ;
4. Empty (Effective immediately) ,

User must fully understand each parameter's definition before modifying any parameter. Two types of user status: end-user and machine maker. Different user status will have different sub-function keys.

■ **Machine Maker**

Eight sub-function keys such as 【SERVO】 , 【MAC】 , 【SPD】 , 【MPG】 , 【PITCH】 , 【HOME】 , 【OPER】 and 【OTHER】 .

■ **End-User**

Three sub-function keys such as 【SERVO】 , 【HOME】 and 【OPER】 .

● **【MODIFY PASSWD】**

User can change password of modifying parameter function. However, password of exit is not to be changed here.

■ **Machine Maker**

1. Password to switch from end-user to machine maker.
2. Password of modifying parameter under machine maker status.

■ **End-User**

Password of modifying parameter under end-user status.

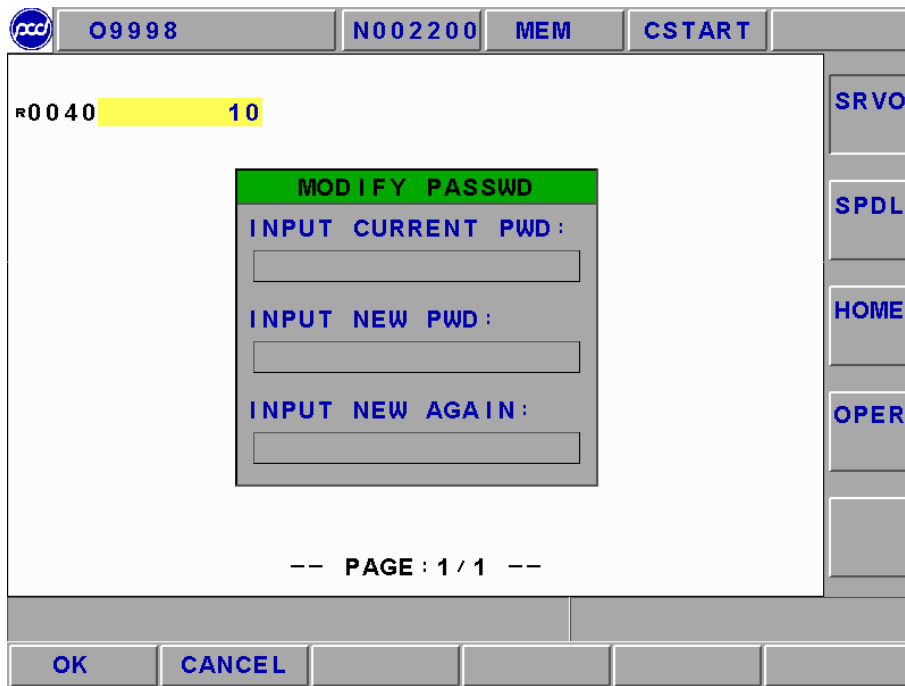

Figure 2.12-1 Chaning Password Page

● **【SWITCH USER】**

Pressing **【switch user】** to switch user status. 「*」 indicates current user status. This function is to let user to switch between end-user to machine maker. When end-user switches to machine maker, system will ask for password. On the other hand, no password needs when switching from machine maker to end-user.

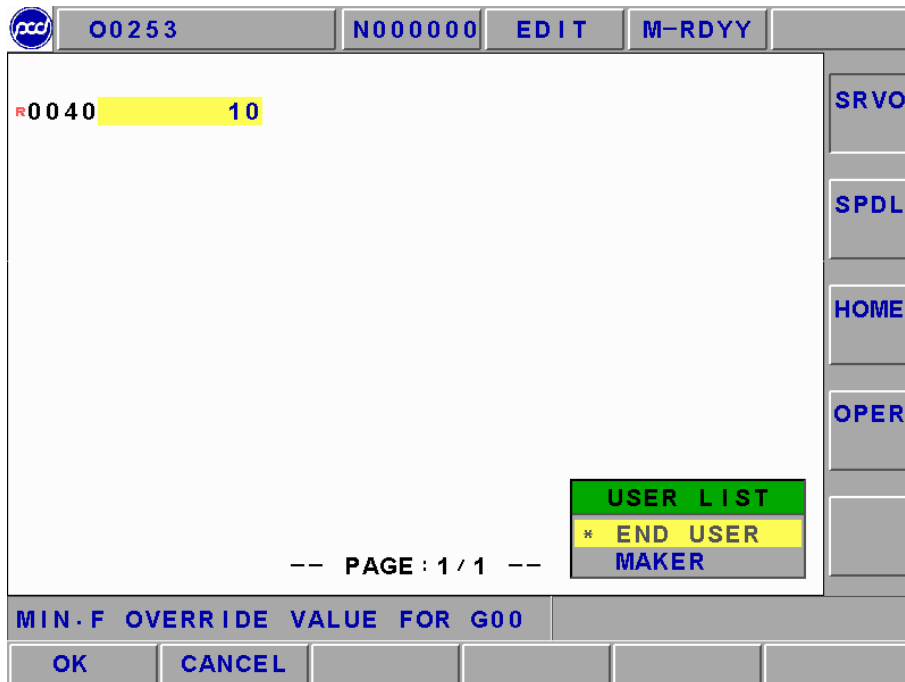

Figure 2.12-2 Switching User Status Page

2.12.2 USROPT (Users Parameter)

In parameter function group, only able to modify parameter under MDI mode. Must reboot after complete modification in order for the modified parameter to be effective. The method of modifying parameter is the same as system parameter. Please refer to the previous chapter if there is any question.

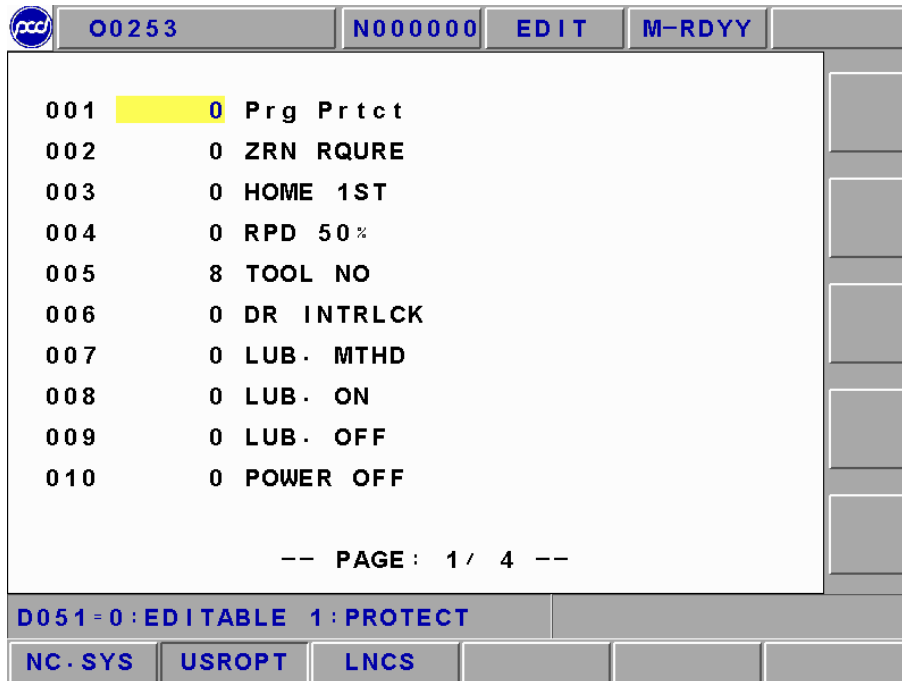

Figure 2.12-3 USROPT

2.12.3 LNCS

This controller has set an internal authorization setting page in order for the producers to trace on customers' payment. But, this function is not a default condition. The default condition is showed as Figure 2.12-4, which only display 1) machine description (**DESC.**), 2) today's date (**DATE**), 3) present time (**TIME**), 4) out of factory date (**MKR.**) and 5) using numbers (**ACC.**).

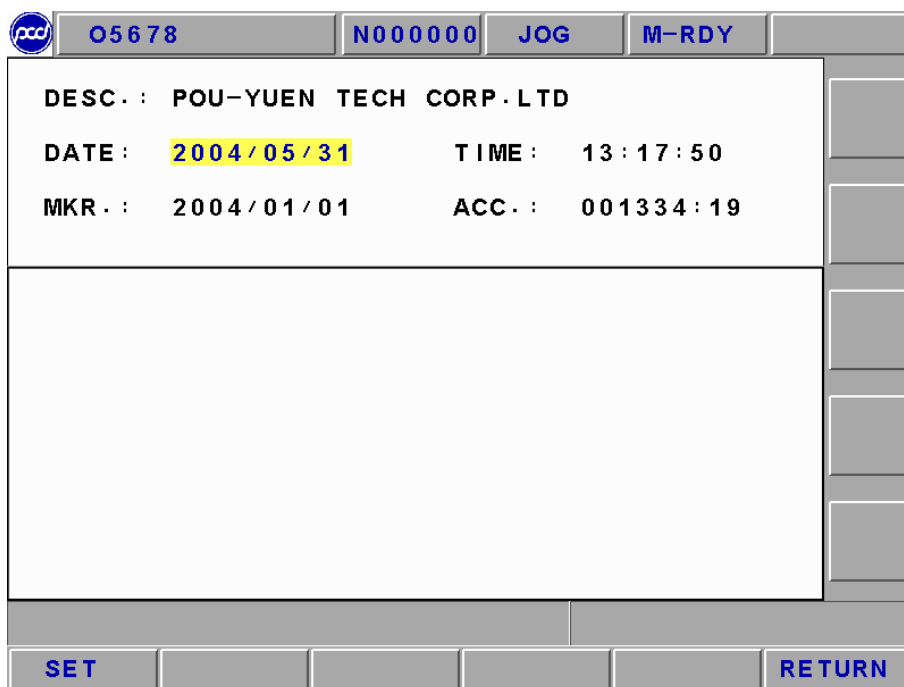

Figure 2.12-4 Default Screen of Authorization Page

- Term authorized requirements for machine makers and/or agents.

1. Key-in correct password (default is 000000) on the authorization page.

NO.	DEADLINECHK	NO.	DEADLINECHK
1	2002/12/30 Y	6	----/--/-- -
2	2003/01/01 Y	7	----/--/-- -
3	2003/01/05 Y	8	----/--/-- -
4	----/--/-- -	9	----/--/-- -
5	----/--/-- -	10	----/--/-- -

Figure 2.12-5 Term Authorization Setting Mode

- Term #:** to assign the term # of the term checking (max term number is 10). If this value has any irregular moving, the original checking condition will set to 'N' (not passing) from 'Y' (passing).
- Expiry Date of Each Term:** to assign the expiry date of each term. Only need to move the cursor to the column to type in the characters when setting.
- Passing Codes of Each Term:** to assign passing codes when the system has noticed a certain expiry date. Users need to press [Unlock] key and key-in the passing codes. Users only need to move the cursor to the column and to press [Codes] to key-in the passing codes in order to complete setting.
- Setting Complete:** This set of passing codes is keyed-in. So only need to key-in the passing codes again when entering into this mode next time. On the other hand, if do not want to change the previous passing codes, please press ENTER.

■ Lock Mode

System will check the expiry date of each term everytime rebooting. The checking method is as below:

1. Whether or not the present date of the system is greater than the expiry date.
2. Whether or not the sum of the out-of-factory date + using days is greater than the expiry days.

If one of the above conditions is met, then the system will disable the “CYCLE START” function due to the expiry date is created. At this time, system alarm 【OP 1017 : System term expire. Please contact supplier.】

■ Release Term Restriction of End-User

1. Contact machine maker/agent to get valid password.
2. Pressing <PARAM> and parameter setting page will occur.
3. Pressing **【Auth】** to enter into authorization page.
4. Pressing the [Unlock Code] key and key-in this term's passing codes.
5. If the passing codes are correct, the CNC system will unlock this term's lock. At the same time, 'Y' will occur on the [CHK] column.
6. Please enable the system again after unlocking in order to release "CYCLE START" restriction.

■ Setting System Date and Time

1. System Date : To move the cursor to the date column and to key-in the correct date format. For example: using [2002/7/11] to do the date setting.
2. System Time : To move the cursor to the time column if want to set the current system time. Using hour:min:sec: format, i.e.,. 11:40:50.

2.13 RESET

<RESET> :

- a. When alarm system is activated, must solve the problem according to the problem. After the condition is release, pressing <RESET> key in order to let the system to work normally.
- b. After editing programs, the cursor stops at somewhere of the program. Using <RESET> in order to move the cursor back to the beginning of the program. Otherwise, the program will start executing at the position where the cursor has occurred.
- c. If pressing <RESET> when the system is executing program, the machine will stop its motion. Also, the cursor will return back to the beginning of the program and returning back to “CNC Ready” condition.

3 OP Panel Operation

3.1 Operation Area

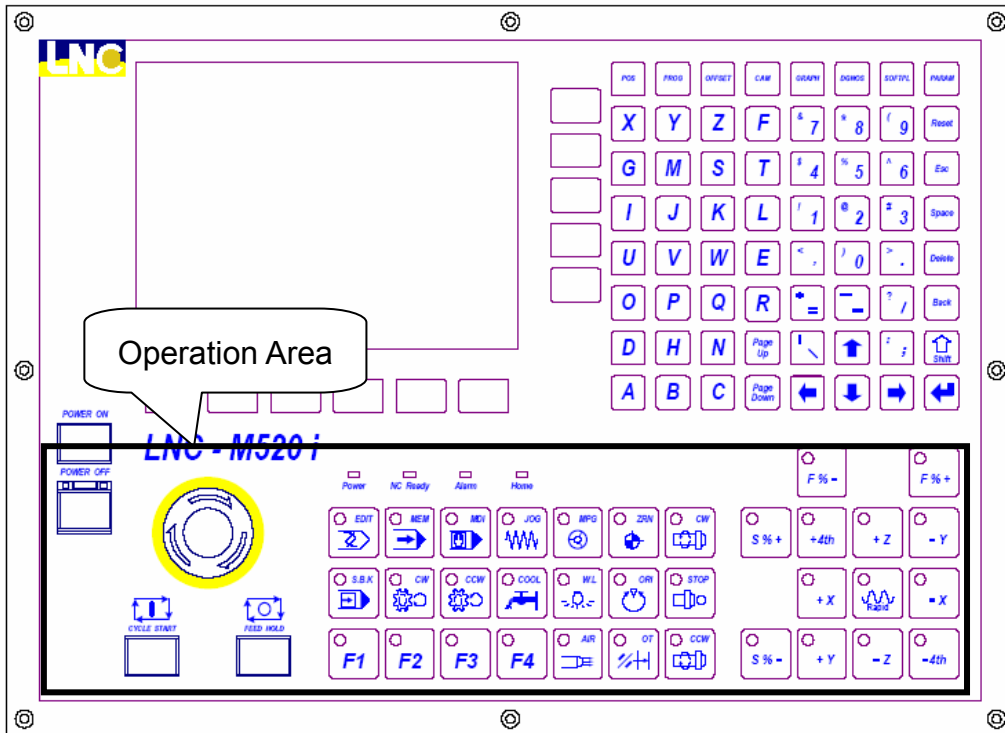

3.2 Power Switch (ON/OFF)



When users press ON button on power switch, the CNC controller's power will be enable. On the other hand, when users press OFF button, must wait for a while until the servo is completely release electricity and then the CNC controller's power will be disable.

3.3 EMG-STOP Key

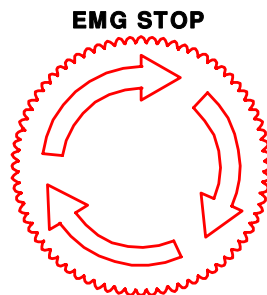

Using this button under the condition of danger or emergency and all motions will stop. To cancel is to turn the button by following the arrow direction. When the button is jump up automatically, the emergency stop is released. When the button is pressed, the system is in "Not Ready" condition (condition column will occur "Not Ready"). In order to reach completed safety, the feed driver power in the power cabinet will be disconnected. Before releasing emergency stop, please ensure whether or not the broken source is excluded. Please executing home return procedure after the emergency stop is released in order to ensure the accuracy of the coordinate position.

3.4 CYCLE START

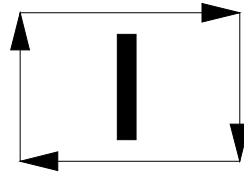

After key-in a program, switching the operation mode to MEM or MDI mode and pressing “CYCLE START” button to executing programs. While the program is executed, this light will be ON. The timings of using “CYCLE START” button are the following:

a. Auto executing in MEM mode:

When a program is selected in MEM mode, pressing “CYCLE START” button to execute the program. The light will remain ON during program executing time until the program execution is finished.

Before executing program, the three axes must return to the reference point. If not returning back to the reference point, users can switch the “Reference Need to OFF” on the Users Define screen. By doing this, program will be able to execute without returning back to the reference point.

b. Auto executing in MDI mode:

Users can key-in a block of program commanding such as G91 G01 X100. Z100 in MDI mode. Then pressing “CYCLE START” button to execute this single block command. The intension of this executing mode is different than that of MEM mode, which is always used in testing some motion. The light will remain ON during executing time until the executing is finished.

3.5 FEED HOLD

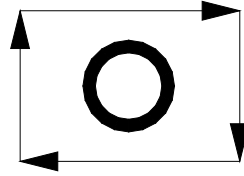

Pressing this button to stop program executing temporarily. During the pause time, “FEED HOLD” light will be ON. M, S and T will remain in the current condition. Please press the “CYCLE START” button again in order to continue executing the unfinished program.

3.6 LED SIGNAL



Power : this light will be ON to ensure the power is ON.

NC Ready : this light will be ON after self-hardware connection testing is confirmed.

Alarm : this light will be ON automatically after confirm servo system works unnormally.

Home : this light will be ON when home mode is active.

3.7 MODE SELECT



There are 7 modes on this operation panel, which are: MDI, MEM, EDIT, JOG, MPG, RAPID and ZRN.

(1) **EDIT**

Users can edit new program or modify old one.

(2) **MEM**

Users can do auto program executing.

(3) **MDI**

Users can execute single block program, modify parameters and setting data.

(4) **JOG**

Users can move axis by choosing moving direction, but the moving speed is decided by feed speed.

(5) **MPG**

Users can use MPG to control the feed of servo axis. All hand wheel control panels provide ratio selection switches, such as 1 ratio, 10 ratio, 100 ratio, and unit means the smallest commanding unit (0.001 mm or 0.0001 inch). Axis direction selection keys are used on control panel.

(6) **RAPID**

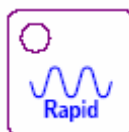

Users can choose axis-moving direction to move axis. The moving speed is decided by the rapid speed button.

(7) ZRN

Operating home return of each axis. When changing to this mode, pressing home return direction button of each axis (the same button as JOG). This axis will start home return procedure according to the setting speed of the parameter until reaching DOG. Also, servo axis starts searching for the home position and it will stop when reaching home point. At this time, this axis +ive direction light will be ON.

Also, when users switches to HOME, this light will be ON in order to remind users to define machine to complete HOME RETURN motion. Please doing the Home Return procedure before doing other part program everytime reboot the machine in order to ensure each coordinate's accuracy.

3.8 AXIS SELECTION

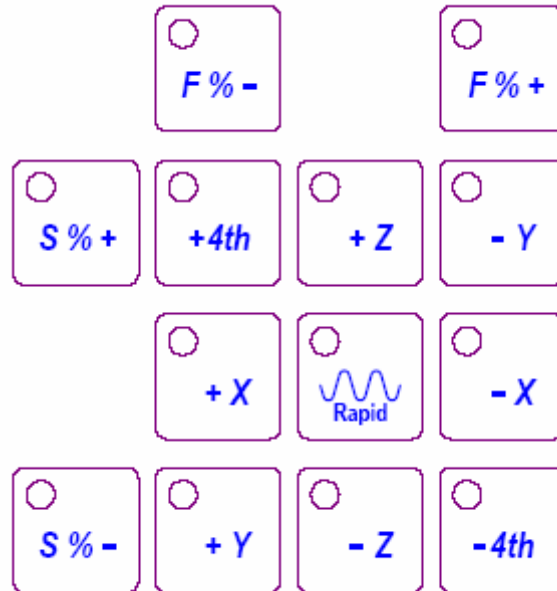

These buttons are used to command moving axis direction under JOG and RAPID modes. For example, pressing +X key under JOG mode, X-axis will move toward +ive direction. Release this key will stop X-axis moving.

3.9 SPINDLE ROTATION



Spindle rotation can be controlled by the following three buttons under 1) MPG, 2) JOG and 3) RAPID modes:

- CW : spindle clockwise rotating
- STOP : spindle stop rotating
- CCW : spindle counter clockwise rotating

The rotational command is adjusted between 0% ~ 120% no matter the spindle is rotating clockwise or rotating counter clockwise in MPG mode. But, users must pay attention when direction changing. Must rotating via STOP procedure, otherwise it will not be effective.

3.10 OT RELEASE

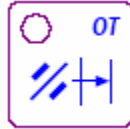

OT REL is the short name of Over Travel RElease. There is one limit switch at end of each traveling side of servo axis in order to prevent to damage servo structure by colluding. When servo structure reaches traveling limit, over traveling will occur, which implies emergency stop. When the screen has “EMERGENCY STOP OR OVER TRAVEL” and this light is ON, please check whether or not the servo structure is over traveling.

If it is over traveling, change the mode to MPG or JOG mode first. Then pressing this light (let this light ON), so the controller will ignore this over traveling emergency situation temporarily. This implies that users can use hand wheel or axis-direction key to move servo axis back to the travel range. Releasing (OT REL) button at this time in order to let the system to continue travel checking.

If everything is working normally, which means “CNC Ready” will replace “CNC Not Ready”, then continue operating. If other warning messages occur, please press [RESET] button before returning back to normal. Please be careful about moving direction, and moving speed while moving the servo structure in order to prevent collusion.

Note: It is possible that over traveling situation occurs when “NOT Ready” condition occurs without any prediction. Please put the over traveling condition into the checking item when searching for reasons.

3.11 COOLANT SUPPLY



Pressing this switch is to force coolant water to be ON. Pressing again is to force coolant water to be off.

3.12 TOOL MAGAZINE

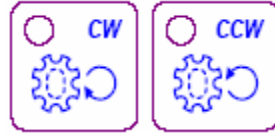

CW : Tool magazine clock-wise rotates. Pressing this button (CW light ON) under MDI mode, tool magazine will rotate in clock-wise direction. The tool magazine will stop at the next position until users fingers let go the button. This button will not be self-maintain, which means whenever users fingers let go the button, the condition will be cancel automatically (CW light OFF).

CCW : Tool magazine counter-clock rotating, the same motion method as CW button.

3.13 Single Block Stop

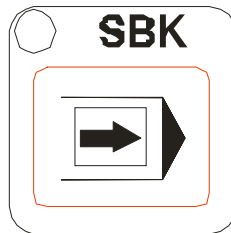

When this button is ON, program operates single program block one by one without continuously motion. Users need to press “CYCLE START” button for every signal program block in order to switch to operating mood

3.14 Additional Function Selection

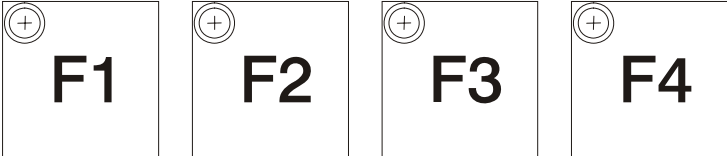

F1 : For machine makers to define

F2 : For machine makers to define

F3 : For machine makers to define

F4 : For machine makers to define